

GARMIN®

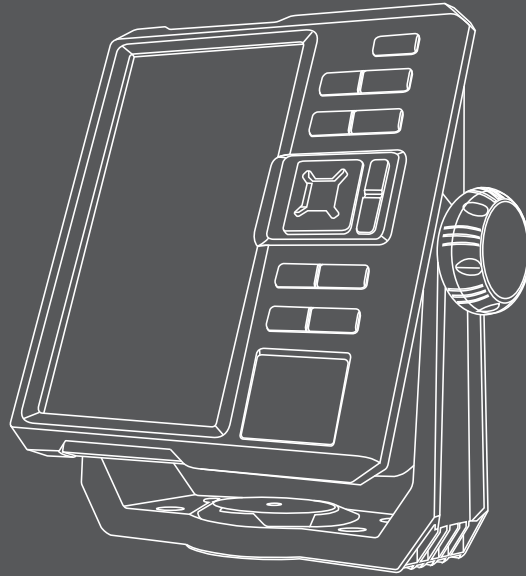

GPSMAP 585 PLUS

Owner's Manual

© 2017 Garmin Ltd. or its subsidiaries

All rights reserved. Under the copyright laws, this manual may not be copied, in whole or in part, without the written consent of Garmin. Garmin reserves the right to change or improve its products and to make changes in the content of this manual without obligation to notify any person or organization of such changes or improvements. Go to www.garmin.com for current updates and supplemental information concerning the use of this product.

Garmin, GPSPMAP, Ultrascroll, and the Garmin logo are trademarks of Garmin Ltd. or its subsidiaries, registered in the USA and other countries. Garmin ClearVü™ and Garmin Quickdraw™ are trademarks of Garmin Ltd. or its subsidiaries. These trademarks may not be used without the express permission of Garmin.

NMEA is a registered trademark of the National Marine Electronics Association.

Table of Contents

Introduction	1	Adding a New Layout to the Home Screen	6
GPSMAP 585 Plus Dimensions	1	Page Shortcuts	6
Device Overview	1	Editing the Page Shortcuts	7
Keys	2	Adding the Numbers or Trip Page	7
Contacting Garmin Product Support	2	Numbers	7
Inserting Memory Cards	2	Trip Page	7
Software Update	3	Adding the Data Graphs Screen	7
Loading the New Software on a Memory Card	3	Adding the Depth Data Graph Page	8
Updating the Device Software	3	Adding the Temperature Data Graph Page	8
Selecting the Transducer Type	3	Data Fields	8
Zooming In and Out of the Chart	3	Sonar	8
Panning on the GPSMAP 585 Plus	3	Full Screen Sonar	8
Adjusting the Backlight	3	Garmin ClearVü Sonar View	9
Changing the Color Mode	4	Traditional 50/77/200 kHz Sonar	10
Configuring the Display Colors	4	CHIRP Sonar	10
Setting the Beeper	5	ClearVü Scanning Sonar	10
GPS Satellite Signal Acquisition	5	Split-Screen Frequency	11
Home Screen	5	Shift-Zoom View	11
Customizing the Home Screen	5	Adjusting the Zoom	12

Bottom Lock	12
Shift Zoom	13
Auto	13
Reducing the Clutter	14
Pausing the Sonar Display	14
Creating a Mark or Waypoint on a Sonar Screen Using Your Present Location.....	14
Creating a Waypoint on a Sonar Screen Using a Different Location...	14
Sonar Frequencies.....	14
Selecting Frequencies	15
Creating a Frequency Preset.....	15
Sonar Gain	16
Setting the Gain Automatically.....	16
Setting the Gain Manually.....	17
Adjusting the Range of the Depth Scale	17
Sonar Setup	17
Showing and Adjusting the Depth Line.....	17
Setting the Scroll Speed	18
Sonar Appearance Settings.....	18
Advanced Sonar Settings	19
Interference.....	20
Surface Noise	20

Color Gain.....	21
TVG.....	21
Overlay Numbers Settings.....	21
Compass.....	22
Depth and Water Temperature Graphs	22

Charts and 3D Chart Views.....22

Navigation Chart and Offshore Fishing Chart	23
Chart Symbols	23
Viewing Location and Object Information on a Chart.....	24
Navigating to a Point on the Chart.....	24
Viewing Details about Nav aids	24
Chart and 3D Chart Settings.....	25
Marks, Waypoints, and Tracks on the Charts and Chart Views.....	25
Other Vessels on the Charts and Chart Views.....	25
Navigation and Fishing Chart Setup.....	26
Overlay Numbers.....	26
Showing a Navigation Inset.....	27
Chart Appearance Settings.....	27
Fish Eye 3D Settings	28
Garmin Quickdraw™ Contours Mapping	28
Accessing the Garmin Quickdraw Community.....	31

Sharing Your Garmin Quickdraw Contours Maps with the Garmin Quickdraw Community	31
Downloading Garmin Quickdraw Community Maps	32

Waypoints and Marks 32

Creating a Mark or Waypoint on a Sonar Screen Using Your Present Location.....	32
Creating a Waypoint on a Sonar Screen Using a Different Location...	33
Creating a Mark or Waypoint	33
Editing a Saved Waypoint.....	33
Marking and Navigating to a Man Overboard Location.....	33
Navigating to a Waypoint.....	33
Deleting a Waypoint or an MOB	33
Deleting All Waypoints	34
Copying Waypoints, Routes, and Tracks to a Memory Card	34
Sharing Waypoints and Routes Across Devices	34
User Data Settings.....	34

Routes 34

Creating and Navigating a Route Using the Waypoint Map.....	34
Creating and Navigating a Route Using the Waypoint Map.....	35
Creating and Navigating a Route Using the Waypoint List.....	35

Editing a Saved Route	35
Viewing a List of Routes	35
Browsing for and Navigating a Saved Route	36
Deleting a Saved Route.....	36
Deleting All Saved Routes	36

Track 36

Setting the Color of the Track	36
Clearing the Track.....	36
Managing the Track Log Memory During Recording	36
Configuring the Recording Interval of the Track Log.....	36
Deleting All Saved Waypoints, Routes, and Tracks	37

AIS Radar 37

Adjusting the AIS Radar Range.....	37
Marking a Waypoint on the AIS Radar Screen.....	38
Viewing a List of AIS Threats.....	38
Creating an AIS Group.....	38
Customizing the Display of the AIS Radar Screen.....	38
Enabling AIS Transmission Test Alerts	38
Setting the Safe-Zone Collision Alarm.....	39
VRM and EBL	39

Showing the VRM and EBL	39
Measuring the Range and Bearing to a Target Object	40
AIS Radar Appearance Settings	40
Highway Page.....	40
Opening the Highway Page	40
Showing and Customizing the Highway Overlay Numbers	41
Auto Guidance	41
Auto Guidance Path Configurations	42
Adjusting the Distance from Shore	42
Digital Selective Calling	44
Networked Chartplotter and VHF Radio Functionality	44
Turning On DSC.....	44
DSC List	44
Viewing the DSC List	44
Adding a DSC Contact.....	44
Incoming Distress Calls	44
Navigating to a Vessel in Distress	44
Position Tracking.....	44
Viewing a Position Report.....	44

Navigating to a Tracked Vessel	45
Creating a Waypoint at the Position of a Tracked Vessel	45
Editing Information in a Position Report	45
Deleting a Position-Report Call	45
Viewing Vessel Trails on the Chart	45
Individual Routine Calls	45
Selecting a DSC Channel.....	45
Making an Individual Routine Call	46
Making an Individual Routine Call to an AIS Target	46

Tide, Current, Lunar Calendar, and Celestial Information

46

Celestial Information	46
Viewing Information for a Different Tide Station	46
Lunar Calendar	47

Device Configuration.....

47

GPSMAP 585 Plus Settings Menu Tree.....	47
System Settings	49
System Information.....	49
My Vessel Settings.....	49
Setting the Keel Offset	50

Setting the Water Temperature Offset	51
Calibrating a Water Speed Device	51
Alarms Settings	51
System Alarms	52
Sonar Alarms	52
Unit Settings	53
Communications Settings	53
NMEA 0183 Settings	53
Navigation Settings	54
Restoring the Factory Default Settings	54
Appendix	55
Registering Your Device	55
Sun Cover	55
GPSMAP 585 Plus Specifications	55
Troubleshooting	56
My device does not turn on	56
My sonar does not work	56
My device is not creating waypoints in the correct location	57
物質宣言	59

Introduction



See the *Important Safety and Product Information* guide in the product box for product warnings and other important information.

GPSMAP 585 Plus Dimensions

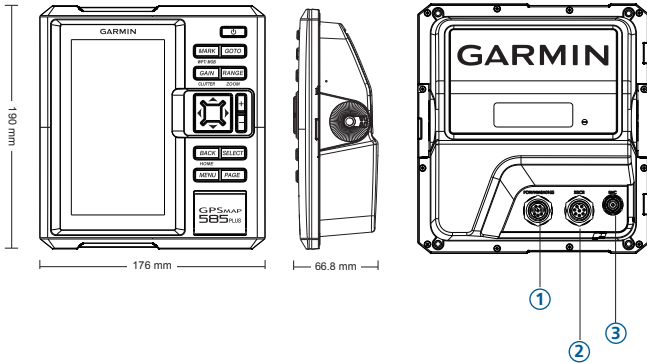





Device Overview



①	Power key
②	Device keys
③	SD card slot

Connector Descriptions	
①	Power/NMEA0183 Data Cable Connector
②	8 pins Transducer Cable Connector
③	BNC External GPS Antenna Cable Connector

Keys

	Hold to turn the device on or off. Select to adjust the backlight, adjust the color mode, configure colors, and enable and disable sonar transmission.
MARK/ WPT MOB	From a 2D chart or sonar page with the sonar paused, select to mark your cursor position as a mark. From a 2D chart with the cursor invisible and no menu shown, select to mark your boat position as a mark. From a 2D chart or sonar page, select MENU > MARK/WPT to mark your boat position as a mark. From any other page, select to mark your boat position as a mark. From a 2D chart or sonar page with the sonar paused, hold to mark your cursor position as a waypoint. From a 2D chart with the cursor invisible and no menu shown, hold to mark your boat position as a waypoint. From a 2D chart or sonar page, select MENU , and hold MARK/WPT to mark your boat position as a waypoint. From any other page, hold to mark your boat position as a waypoint. Hold to open the man overboard (MOB) option.
GOTO	Select to go to a selected waypoint or location.
GAIN/ CLUTTER	From a sonar screen, select to adjust the gain. From a sonar screen, hold to open the clutter menu.
RANGE/ZOOM	From a sonar screen, select to adjust the sonar range. From a sonar screen, hold to open the zoom menu.
	Select to scroll, highlight options, and move the cursor.
	Select to scroll, highlight options, and move the cursor. Select to pause sonar.
	Select to zoom in to a view.
	Select to zoom out of a view.

BACK	Select to return to the previous screen. Hold to return to the home screen.
SELECT	Select to select options and acknowledge messages.
MENU	Select to open the options menu for each page.
PAGE	Select to scroll through pages.

Contacting Garmin Product Support

Go to www.garmin.com.sg/support for in-country support information.

Inserting Memory Cards

You can use optional memory cards in the chartplotter. Map cards allow you to view high-resolution satellite imagery and aerial reference photos of ports, harbors, marinas, and other points of interest. You can use blank memory cards to record sonar/QuickDraw data and transfer data such as waypoints, routes, and tracks to another compatible Garmin chartplotter or a computer.

- 1 Open the access flap or door on the front of the chartplotter.
- 2 Insert the memory card.
- 3 Press the card in until it clicks.

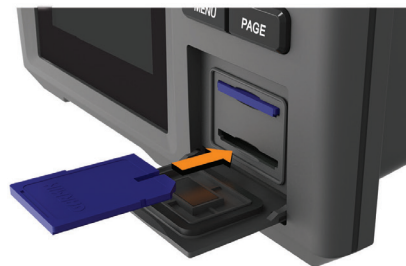

- 4 Close the door.

Software Update

You may need to use the memory card to update the device software when you install the device or add an accessory to the device.

Loading the New Software on a Memory Card

- 1 Insert a memory card into the card slot on the computer.
- 2 Go to www.garmin.com/support/software/marine.html.
- 3 Select **Download** next to **GPSMAP Series with SD Card**.
- 4 Read and agree to the terms.
- 5 Select **Download**.
- 6 Select **Run**.
- 7 Select the drive associated with the memory card, and select **Next > Finish**.

Updating the Device Software

Before you can update the software, you must obtain a software-update memory card or load the latest software onto a memory card.

- 1 Turn on the chartplotter.
- 2 After the home screen appears, insert the memory card into the card slot.
NOTE: In order for the software update instructions to appear, the device must be fully booted before the card is inserted.
- 3 Follow the on-screen instructions.
- 4 Wait several minutes while the software update process completes.
- 5 When prompted, leave the memory card in place and restart the chartplotter manually.

- 6 Remove the memory card.

NOTE: If the memory card is removed before the device restarts fully, the software update is not complete.



Selecting the Transducer Type

If you are not using the included transducer from the giftbox, you must set the transducer type to enable the sonar to function optimally. If you are using the included transducer, you do not need to complete these steps.

- 1 Select **Settings > My Vessel > Transducer Type**.
- 2 Select the type of transducer you are using.

Zooming In and Out of the Chart

The zoom level is indicated by the scale number at the bottom of the chart. The bar under the scale number represents that distance on the chart.

- Select  to zoom out.
- Select  to zoom in.

Panning on the GPSMAP 585 Plus

You can move the chart to view an area other than your present location.

Use the arrow keys to pan.

Adjusting the Backlight

- 1 Select **Settings > System > Display > Backlight**.

TIP: Press  > **Backlight** from any screen to open the backlight settings.

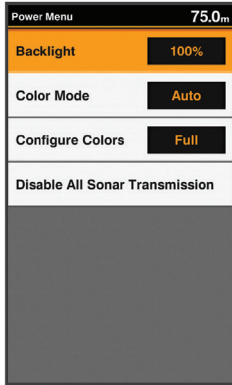

2 Adjust the backlight.

Changing the Color Mode

1 Select **Settings** > **System** > **Display** > **Color Mode**.

TIP: Press  > **Color Mode** from any screen to access the color settings.

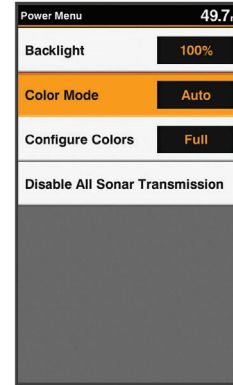

2 Select an option:

- To use a light background, select **Day Colors**.
- To use a dark background, select **Night Colors**.
TIP: You can configure the night color mode. Select **Configure Colors**, and select an option.
- To allow the device to display day or night colors automatically, based on the time of day, select **Auto**.

Configuring the Display Colors

Before you can configure night colors, you must have the color mode set to night colors (page 4).



Select **Settings** > **System** > **Display** > **Configure Colors**.

Setting the Beeper

You can set when the device makes sounds.

- 1 Select **Settings > System > Beeper**.
- 2 Select an option:
 - To have the device beep when you select an item and when an alarm is triggered, select **On (Selections and Alarms)**.
 - To have the device beep only when alarms are triggered, select **Alarms Only**.

GPS Satellite Signal Acquisition

When you turn on the COMBO unit, the GPS receiver must collect satellite data and establish the current location. When the fishfinder acquires satellite signals,  appears at the top of the Home screen. When the fishfinder loses satellite signals,  disappears and a flashing question mark appears over  on the screen.

For more information about GPS, go to www.garmin.com/aboutGPS.

Home Screen

The home screen provides access to all of the features in the device. The features are dependant on the accessories you have connected to the device.

When viewing another screen, you can return to the home screen by holding BACK. You can customize the layout of the screens and the items shown on the home screen.

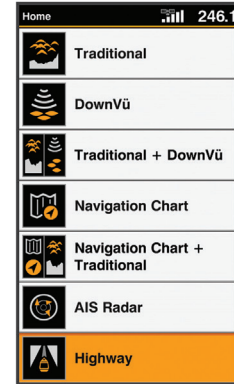

Customizing the Home Screen

You can add items to and rearrange items on the Home screen.

- 1 From the Home screen, select **Customize Home**.
- 2 Select an option:
 - To rearrange an item, select **Rearrange**, select the item to move, and select the new location.
 - To add an item to the Home screen, select **Add**, and select the new item.
 - To remove an item you have added to the Home screen, select **Remove**, and select the item.

Adding a New Layout to the Home Screen

You can create a custom screen to suit your needs, which is added to your home screen.





- 1 Select **Customize Home > Add > Add New Layout**.
- 2 Select the first and second screens to include in the layout.
- 3 Select an display option:
 - To change the orientation of the display windows, select **Horiz** or **Vert** in **Split**..
 - To customize the data shown on the screen, select **+ Highway > Overlay Numbers > Overlay Numbers**.
 - To turn on and off the compass tape data bar, select **+ Highway > Overlay Numbers > Overlay Numbers > Compass Tape**.
- 4 Select **Next**.
- 5 Enter a name for the layout.
TIP:
 - Select **SELECT** to save.
 - Hold **MENU** to clear data.
 - Select **+** or **-** to change letter case.
- 6 Use the arrow keys to resize the windows.
- 7 Use the arrow keys to select location in the home screen.

Page Shortcuts

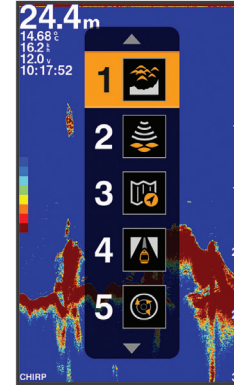













You can quickly open commonly used pages by selecting PAGE from any page.

You also can edit the Shortcuts window depending on your request.

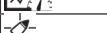

	Traditional
	ClearVü
	Navigation Chart
	Highway
	AIS Radar

Default Shortcuts

	Shift Zoom
	ClearVüSplit Zoom
	Split Frequency
	Depth Data Graph
	Temperature Data Graph
	Sonar Recordings
	Fishing Chart
	Mariner's Eye 3D
	Fish Eye 3D
	Numbers
	Compass
	Trip
	Speed Data Graph
	GPSMAP 585 Plus Navigation Chart

Available Shortcuts

Editing the Page Shortcuts

Before you can change a page in the shortcuts menu, you must add the page to your home screen (page 5).

You can change the pages that appear in the shortcuts menu.

- 1 From the page you want to add to the shortcuts menu, hold **PAGE**. An editable shortcuts menu appears.
- 2 Select **PAGE** to select the location in the menu for the shortcut.
- 3 Select **SELECT > Yes**.

Adding the Numbers or Trip Page

Before you can customize the Numbers or Trip screens, you must add them to the home screen.

- 1 Select **Customize Home > Add > Navigation Info**.
- 2 Select **Numbers** or **Trip**.

Numbers

To customize the Numbers screen, select **Numbers > MENU**. **Change Numbers**: Sets what type of data is displayed.

Change Layout: Sets the amount of number data that is displayed.

Trip Page

To customize the Trip screen, select **Trip > MENU**.

Reset Trip: Resets the trip data and allows you to record new trip data.

Reset Odometer: Resets the odometer data and allows you to record new odometer data.

Reset Maximum Speed: Resets the maximum speed for the trip and allows you to record a new maximum speed.

Adding the Data Graphs Screen

Before you can customize the Speed Data Graph screen, you must add it to the home screen.

You can view graphical sonar data on the home screen using the Speed Data Graph screen.

From the home screen, select **Customize Home > Add > Speed Data Graph**.

Adding the Depth Data Graph Page

Before you can customize the Depth Data Graph page, you must add it to the home screen.

From the home screen, select **Customize Home > Add > Sonar > Depth Data Graph**.

Adding the Temperature Data Graph Page

From the home screen, select **Customize Home > Add > Temperature Data Graph**.

Data Fields

Data fields display multiple types of information in one area, such as depth, heading, and bearing. Some data fields require you to be navigating or require a connection to sensors to display data. For example, a temperature sensor must be connected to the chartplotter to display the temperature data field.

The data fields on a page depend on the type of data associated with that page. For example, a sonar page automatically displays sonar-related information such as Depth.

You can configure the data fields that display on a page. The different data will depend on the different working mode. Select **MENU > Overlay Numbers**.

GPS Speed 0.00 $\frac{\text{k}}{\text{h}}$	GPS Heading 004 $^{\circ}$ $\frac{\text{M}}$	Depth 23.5 m
Dist. to Dest. 1305 $\frac{\text{k}}{\text{m}}$	Arrival --:--	Bearing 004 $^{\circ}$ $\frac{\text{M}}$

Sonar

Full Screen Sonar

You can see a full-view graph of sonar readings from a transducer on the full screen.

Select **Traditional**.

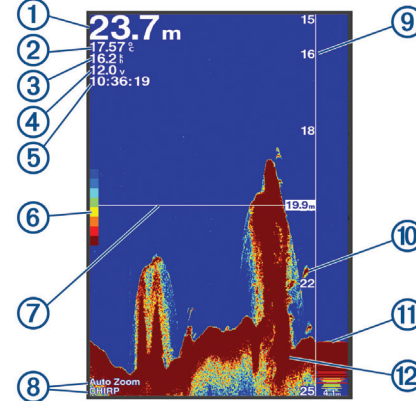

①	Bottom depth
②	Water temperature
③	GPS speed
④	Device voltage
⑤	Time
⑥	Color bar
⑦	Depth line
⑧	Transducer type and frequency, zoom type, and color filter status
⑨	Depth indicator as the sonar data screen scrolls from right to left
⑩	Suspended targets (fish school)
⑪	A-scope
⑫	Bottom echo

Garmin ClearVü Sonar View

NOTE: To receive Garmin ClearVü scanning sonar, you need a compatible transducer.

Garmin ClearVü high-frequency scanning sonar provides a detailed picture of the fishing environment around the boat in a detailed representation of structures the boat is passing over.

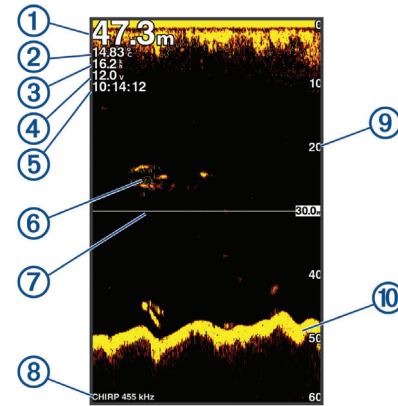

①	Bottom depth
②	Water temperature
③	GPS speed
④	Device voltage
⑤	Time
⑥	Suspended targets (fish)
⑦	Depth line
⑧	Transducer type and frequency, and zoom type
⑨	Depth indicator as the sonar data screen scrolls from right to left
⑩	Bottom echo

Traditional transducers emit an ultrasonic conical beam.

Traditional 50/77/200 kHz Sonar

Fishfinder uses ultrasonic signals to detect the bottom of the ocean. Traditional 50/77/200 kHz sonar sends only one frequency at a time. Since the only feedback is from this one single frequency, there is limited information to work with, restricting the clarity and resolution. Lower frequencies with wider sonar beam angle would result in a broader and deeper detectable area. Conversely, higher frequencies with narrower beam angle would result in higher resolution images with better target separation.

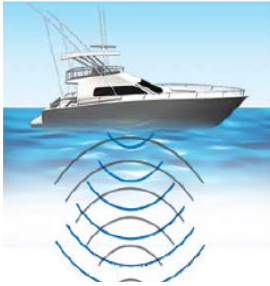

CHIRP Sonar

CHIRP sonar is one of the most sophisticated sonar technologies available for the fishing and boating public. The word is an acronym for Compressed High-Intensity Radiated Pulse (C-H-I-R-P). CHIRP sonar provides amazingly clear target separation and definition because it puts more energy onto the target than traditional sonars.

Instead of sending just one single frequency, CHIRP sonar sends a continuous sweep of frequencies ranging from low to high. Garmin CHIRP sonar technology then interprets each frequency individually upon its return. This provides much more information, from which CHIRP sonar is able to construct a much clearer, higher resolution image with greater target

separation and crisper fish arches.

For example, 80-160 kHz sonar sweeps through the entire range from 80 kHz all the way up to 160 kHz, hitting every single frequency in between.

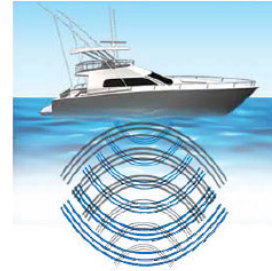

ClearVü Scanning Sonar

The Garmin ClearVü scanning sonar technology takes one step further by emitting two narrow beams with CHIRP technology, similar to the shape of the beam in a copying machine.

This Garmin high-frequency scanning sonar (260/455/800 kHz) provides a much clearer, picture-like image of what lies under the water by producing a more detailed representation of objects, structures and fish under your boat.

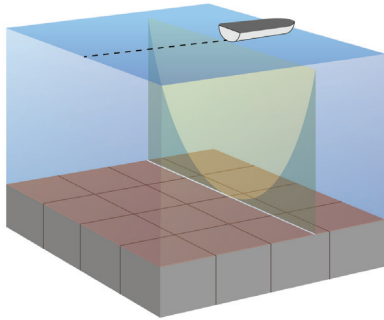

Shift-Zoom View

On the sonar screen, you can see a full-view graph of sonar readings on the right side of the screen, and a magnified portion of that graph on the left side of the screen.

Shift allows you to set the depth range on which the sonar is focused. This allows you to zoom in a higher resolution in the focused depth.

When using shift, bottom tracking may not work effectively, because the sonar looks for data within the depth range of the focused area, which may not include the bottom. Using shift also can impact the scroll speed, because data outside the depth range of the focused area is not processed, which reduces the time required to receive and display the data. You can zoom in to the focused area, which enables you to evaluate target returns more closely at a higher resolution than just zooming alone.

Split-Screen Frequency

You can view two frequencies from the split frequency screen. This screen is useful for the same target comparison between two different frequencies.

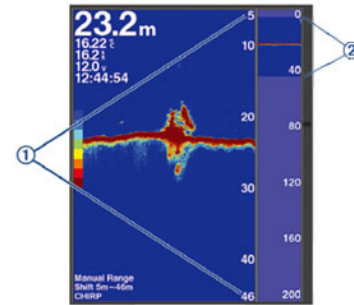
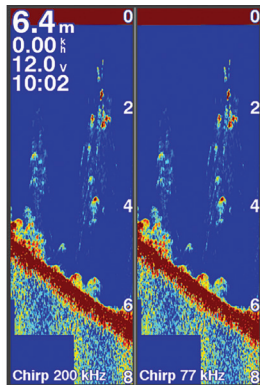

①	Zoomed depth scale
②	Depth range

Adjusting the Zoom

You can adjust the zoom manually by specifying the span and a fixed starting depth. For example, when the depth is 15 m and the starting depth is 5 m, the device displays a magnified area from 5 to 20 m deep.

You also can allow the device to adjust the zoom automatically by specifying a span. The device calculates the zoom area from the bottom of the water. For example, if you select a span of 10 m, the device displays a magnified area from the bottom of the water to 10 m above the bottom.

- 1 From a sonar screen, select **RANGE/ZOOM**.

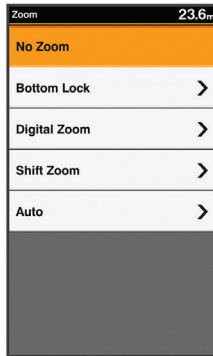

- 2 Select an option:

- Select **No Zoom** to not use the zoom feature.
- Select **Bottom Lock** to lock the screen to the water bottom.
- Select **Manual** or **Digital Zoom** to manually set the zoom.
- Select **Shift Zoom** to manually adjust the zoom.
- Select **Auto** to automatically set the zoom.

Bottom Lock

You can lock the screen to the water bottom. For example, if you select a span of 20 meters, the device shows an area from the water bottom to 20 meters above the bottom. It is useful for detecting fish close to the bottom. The span appears on the right side.

- 1 From a sonar view, select **MENU > ZOOM > Bottom Lock**.
- 2 Select ◀ and ▶ to adjust the depth range above the bottom.

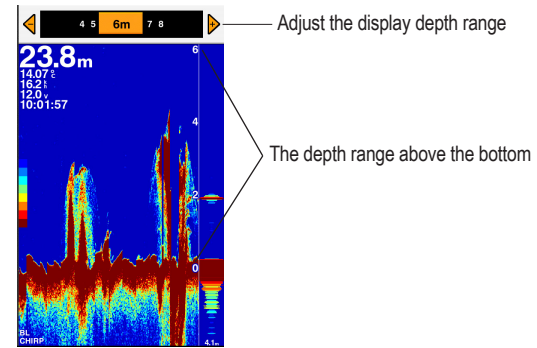

Digital Zoom

Digital zoom magnifies the image after it is captured by sonar. It expands a chosen area of the sonar picture to vertically fill the left-side of the screen. You can set the zoom manually.

- 1 From a sonar screen select **RANGE/ZOOM > Digital Zoom**.
- 2 Select ▲ or ▼ to select between Zoom and Depth.
- 3 Select ◀ and ▶ to adjust the value.

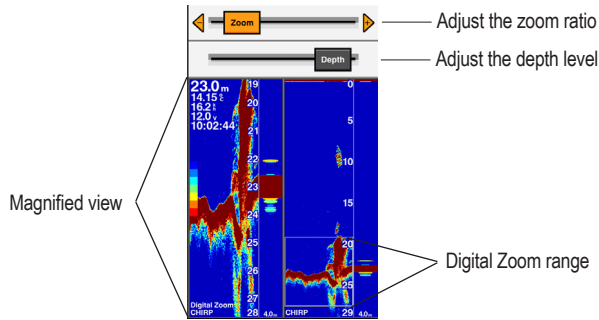

Shift Zoom

This is a unique sonar zoom technology from Garmin. It displays the selected depth and range of sonar to fill the left-side of the screen in more accuracy and detail. In the Shift Zoom mode the fishfinder CPU only processes the sonar signals received from the selected depth range. You can set the zoom manually.

- 1 From a sonar screen select **RANGE/ZOOM > Shift Zoom**.
- 2 Select ▲ or ▼ to select Range or Depth.
- 3 Select ◀ and ▶ to adjust the value.

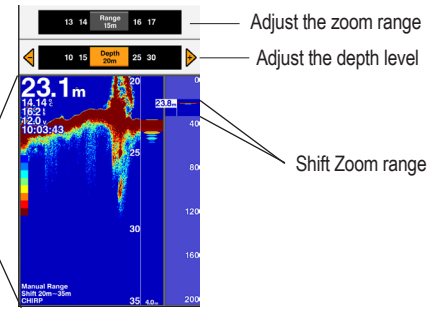

Auto

Auto zoom is similar to Bottom Lock but displays a magnified view on the left-side of the screen of the bottom and bottom fish in the set zoom range. The Auto mode is good for determining the bottom contour. It allows you to change the depth range above the bottom and the zoom ratio while always showing the water bottom.

- 1 From a sonar screen select **RANGE/ZOOM > Auto**.
- 2 Select ◀ and ▶ or + and - to adjust the zoom range.

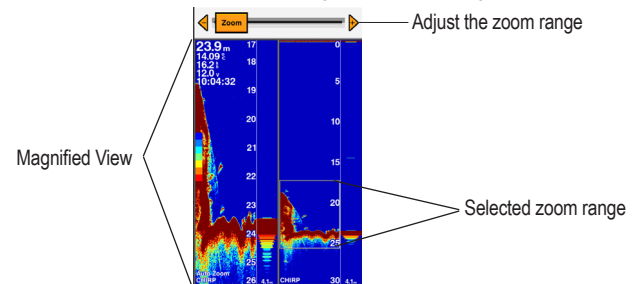

Reducing the Clutter

You can quickly change the settings to reduce noise and clutter on the sonar screen.

- 1 From a sonar view, hold **GAIN/CLUTTER** to open the Clutter Menu.

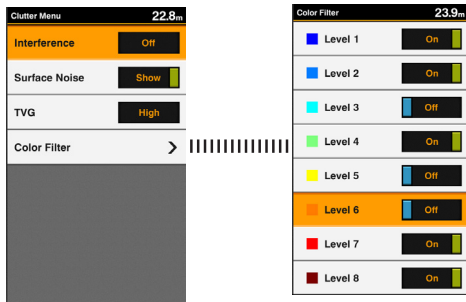

- 2 Select one or more options:
 - To adjust the sensitivity to reduce the effects of interference from nearby sources of noise, select **Interference**.
 - To hide sonar returns near the surface of the water, select **Surface Noise**.
 - To adjust the time varying gain, which can reduce noise, select **TVG**.
 - To filter specified colors representing different sonar signal's strengths and identify targets of interests, select **Color Filter**.

Pausing the Sonar Display

You can pause the sonar to create a mark or a waypoint.

Select ◀ or ▶ .

Creating a Mark or Waypoint on a Sonar Screen Using Your Present Location

- 1 Pause the sonar.
- 2 Select an option:
 - To create a mark at the cursor, select **MARK/WPT**.
 - To create a waypoint at the cursor, hold **MARK/WPT**.
 - To create a mark at your boat position, with the cursor invisible and no menu shown, select **MARK/WPT**.
 - To create a waypoint at your boat position, with the cursor invisible and no menu shown, select **MARK/WPT**.
- 3 If necessary, edit the mark or waypoint information.

Creating a Waypoint on a Sonar Screen Using a Different Location

- 1 Select ◀ or ▶ to pause the sonar.
- 2 Using the arrow keys, select a location.
- 3 Select an option:
 - To create a mark, select **MARK**.
 - To create a waypoint, hold **MARK**.
- 4 If necessary, edit the mark or waypoint information.

Sonar Frequencies

NOTE: The frequencies that are available depend on the transducer being used. Adjusting the frequency helps adapt the sonar for your particular goals and the present depth of the water.

Lower frequencies scans a wider area, and are thus suitable for general

search and judging the bottom conditions.

Higher frequencies results in better resolutions, and are thus more useful for detailed observations of fish echoes.

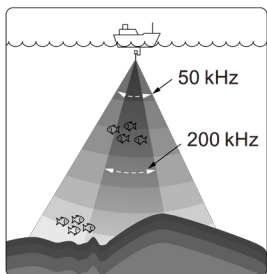

Frequency and coverage area

Selecting Frequencies

50 kHz

The fishfinder uses ultrasonic signals to detect bottom. The lower the frequency, the wider and deeper the detection area. The 50 kHz frequency is useful for general detection and judging the bottom condition.

77 kHz

The 77 kHz is fishfinder's mid-frequency with a wider beam angle for detecting schools of fish at the bottom on the edges.

200 kHz

The higher the frequency, the narrower the beam and the higher the resolution. The 200 kHz frequency is ideal for detailed observations.

NOTE: You cannot adjust the frequency for all sonar views and transducers. You can indicate which frequencies appear on the sonar screen.

1 From a sonar view, select **MENU > Frequency**.

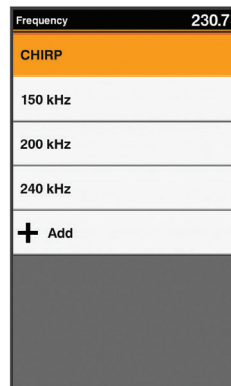

2 Select a frequency suited to your needs and water depth.

Creating a Frequency Preset

NOTE: Not available with all transducers.

You can create a preset to save a specific sonar frequency, which allows you to change frequencies quickly.

1 From a sonar view, select **MENU > Frequency**.

2 Select **Add**.

3 Enter a frequency.

Sonar Gain

The Gain control function amplifies the signal received from the sonar returning echoes. The signal strength from the echoes is stronger in shallow water than in deeper water due to the lesser distance the echo has to travel back to the transducer. The Gain can be operated in “Manual” or “Auto” mode. In “Auto” mode, the signal received from the echoes is automatically amplified. In “Manual” mode, the volume control setting is manually adjusted according to the depth range and the underwater conditions.

If the Gain control is set too low, the signals received from the returning echoes will be weak, reducing the signal strength and the amount of detail recorded on the screen. The Gain setting controls the sonar receiver’s sensitivity to compensate for water depth and water clarity. Increasing the Gain shows more details, and decreasing the Gain reduces screen clutter. This can be corrected by gradually increasing the volume on the Gain control setting until more details appear on the display screen.

If the Gain control is set too high, the screen will become cluttered as too many signals are received. This can result in a failure to detect which of these are fish targets. It can be corrected by gradually decreasing the volume on the Gain control setting until less clutter appears on the screen.

NOTE: Setting the gain on one sonar view applies the setting to all the views.

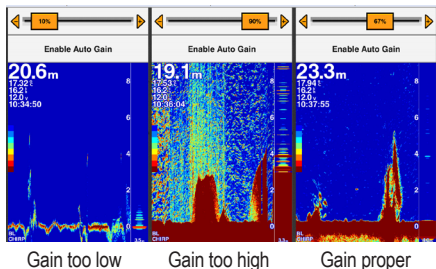

Setting the Gain Automatically

NOTE: To set the gain on the split-frequency screen, you must set each frequency separately.

- 1 From a sonar view, select **GAIN**.

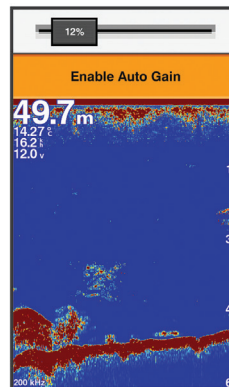

- 2 Select ▼ > **Enable Auto Gain**.

- 3 Select an option:

- To display higher-sensitivity, weaker sonar returns with more noise automatically, select **Auto High**.
- To display medium-sensitivity sonar returns with moderate noise automatically, select **Auto Med**.
- To display lower-sensitivity sonar returns with less noise automatically, select **Auto Low**.

Setting the Gain Manually

- 1 From a sonar screen, select **GAIN**.

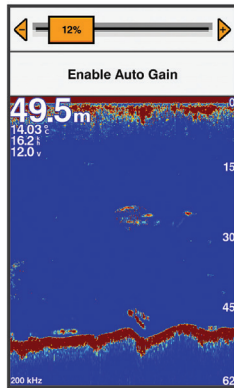

- 2 Select **+** or **▶** until you begin to see noise in the water portion of the screen.
- 3 Select **-** or **◀** to decrease the gain.

Adjusting the Range of the Depth Scale

You can adjust the range of the depth scale that appears on the right side of the screen. Automatic ranging keeps the bottom within the lower third of the sonar screen, and can be useful for tracking the bottom where there are slow or moderate terrain changes.

When the depth changes dramatically, like a drop off or cliff, manually adjusting the range allows a view of a specified depth range. The bottom is shown on the screen as long as the bottom is anywhere within the manual range established.

- 1 From a sonar screen, select **RANGE**.

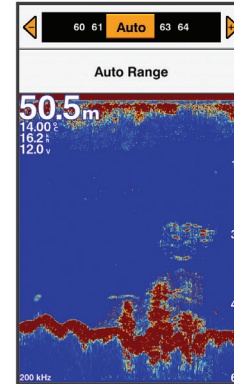

- 2 Select an option:
 - To allow the device to adjust the range automatically based on the depth, select Auto Range.
 - To increase or decrease the range manually, select **+** or **-**.
- NOTE:** From a sonar screen, select **+** and **-** to quickly manually adjust the range.

Sonar Setup

NOTE: Not all options and settings apply to all models, sounder modules, and transducers.

Showing and Adjusting the Depth Line

You can show and adjust a horizontal line on a sonar screen. The depth of the line is indicated on the right side of the screen.

NOTE: Showing a depth line on one screen displays the depth line on all the screens.

- 1 From a sonar screen, select **MENU > Sonar Setup > Depth Line**.
- 2 Select **MENU**.
- 3 To adjust the **Depth Line**, select ▲ or ▼ .

Setting the Scroll Speed

You can set the rate at which the sonar image moves across the screen. A higher scroll speed shows more detail, especially while moving or trolling. A lower scroll speed displays sonar information on the screen longer. Setting the scroll speed on one sonar view applies to all the sonar views.

- 1 From a sonar view, select **MENU > Sonar Setup > Scroll Speed**.

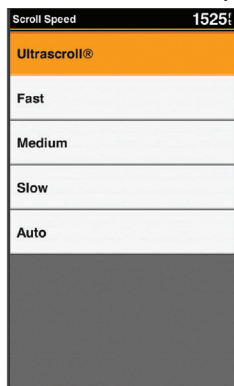

- 2 Select an option:
 - To adjust the scroll speed automatically using speed-over-ground, select **Auto**.

The Auto setting selects a scroll rate to match the boat speed, so targets in the water are drawn with the correct aspect ratio and appear less distorted.

- To use a very fast scroll speed, select **Ultrascroll**. The Ultrascroll option quickly scrolls new sonar data, but with a reduced image quality. For most situations, the Fast option provides a good balance between a quickly scrolling image and targets that are less distorted.

Sonar Appearance Settings

From a sonar view, select **MENU > Sonar Setup > Appearance**.

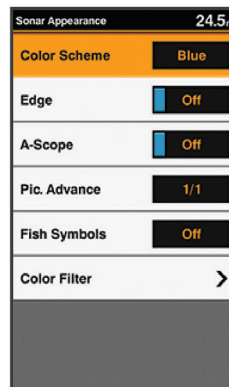

WARNING

Information is for reference only. Disabling warnings for underwater hazards can result in death, personal injury, or property damage. You are responsible for the safe and prudent operation of your vessel.

Color Scheme: Sets the color scheme.

Edge: Highlights the strongest signal from the bottom to help define the hardness or softness of the signal.

A-Scope: Displays a vertical flasher along the right side of the screen that shows instantaneously the range to targets along a scale.

Pic. Advance: Allows the sonar picture to advance faster by drawing more than one column of data on the screen for each column of sounder data received. This is especially helpful when you are using the sounder in deep water, because the sonar signal takes longer to travel to the water bottom and back to the transducer.

The 1/1 setting draws one column of information on the screen per sounder return. The 2/1 setting draws two columns of information on the screen per sounder return, and so on for the 4/1 and 8/1 settings.

Fish Symbols: Sets how the sonar interprets suspended targets.

Color Filter: Sets which colors are removed from the screen.

Turning On the A-Scope

NOTE: This feature is not available in all sonar views.





The a-scope is a vertical flasher along the right side of the full-screen sonar view. This feature expands the most recently received sonar data so that it is easier to see. It can also be helpful for detecting fish that are close to the bottom.

From a sonar view, select **MENU > Sonar Setup > Appearance > A-Scope**.

Configuring the Appearance of Suspended Targets

NOTE: Configuring the appearance of suspended targets on one screen applies that setting to all screens.

NOTE: This feature is not available on all sonar views.

	Shows suspended targets as symbols.
	Shows suspended targets as symbols with target depth information.
	Shows suspended targets as symbols with background sonar information.
	Shows suspended targets as symbols with background sonar information and target depth information.

- 1 From a sonar screen, select **MENU > Sonar Setup > Appearance > Fish Symbols**.
- 2 Select an option.

Advanced Sonar Settings

NOTE: Not all options and settings apply to all models, sounder modules, and transducers.

From a sonar view, select **MENU > Sonar Setup > Advanced**.

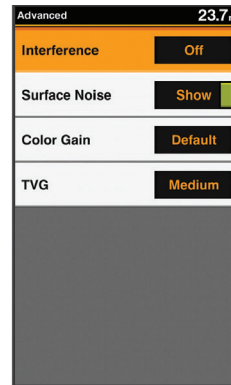

Interference

Adjusts the sensitivity to reduce the effects of interference from nearby sources of noise. The lowest interference setting that achieves the desired improvement should be used to remove interference from the screen.

Correcting installation issues that cause noise is the best way to eliminate interference.

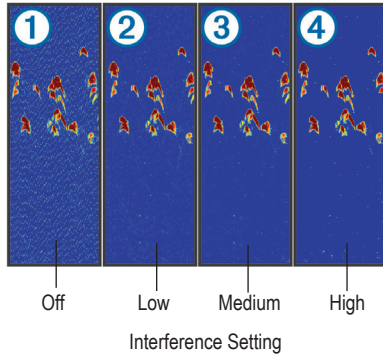

Interference from other acoustic equipment operating nearby or other electronic equipment on your boat may appear on the display as shown in the figures below. You may reduce the effect with a noise limiter. There are varying degrees of interference. Minor interference or noise can be stray signals that can look like actual targets. Severe noise can completely fill the screen and make depth readings impossible. To counter interference, you have to first identify the type of interference. Although most noises can be eliminated with fairly simple techniques, some interferences can only be reduced to a more acceptable level.

- 1. Sonar Cross-Talk interference:** caused by nearby fishfinder(s) of similar transmit frequency. It will appear as the diagonal lines across the screen. When two fishfinder's transducer cones intersect, the units will not be able to tell the signals apart. See figure (A) below.
- 2. Electromagnetic Interference (EMI):** caused by powerful electromagnetic waves radiated from electric equipment and wirings. The electromagnetic waves are then absorbed by the transducer cable and appear as vertical lines on the screen. See figure (B) below.

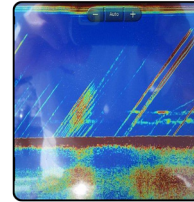

(A) Interference from other sonar

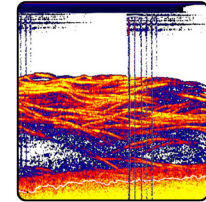

(B) Electrical interference

Surface Noise

When the sea is rough or the ship passes over a wave, surface noise may appear at the top of the screen. It can be suppressed with the CLUTTER function which hides surface noise to help reduce clutter. Wider beam widths (lower frequencies) can show more targets, but can generate more surface noise.

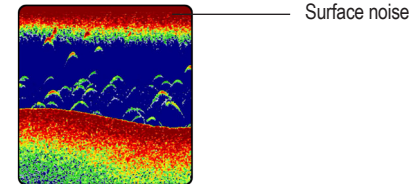

Color Gain

Adjusts the intensity of colors shown on the screen.

You can adjust the Color Gain to change the sonar signal strength threshold for the strongest colors on your sonar screen. Color Gain sets the lower limit for the strongest echo color, all sonar echoes with signal strengths above this value will appear in the strongest color. Other sonar echoes with weaker values are divided equally by the remaining colors.

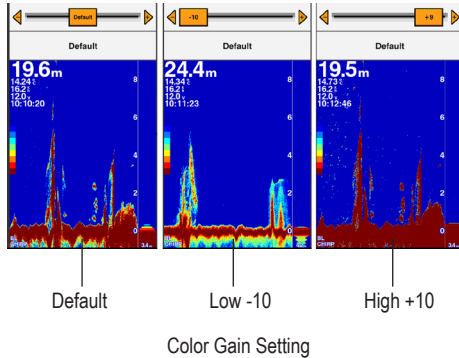

TVG

The TVG (Time Variable Gain) compensates for propagation loss of sound, so that the echoes from fish schools of the same size are displayed in the same color. Avoid excessive TVG; weak echoes may not be displayed. The TVG is also useful for reducing surface noise. TVG is intended to compensate for the fact that close-in returns provide a louder echo than further-away ones by using a lower gain level in the period immediately after the sounder stops transmitting its ping (echoes from nearby objects) and then ramping up the gain level over time as the ping travels into deeper water, attenuating as it goes.

Adjusts the appearance of returns to compensate for weakened sonar signals in deeper water, and reduces the appearance of noise near the surface. When the value of this setting is increased, the colors associated with low-level noise and fish targets appear more consistent through various water depths. The ideal end result of using TVG appropriately is that if you increase Gain until you see a lot of clutter on the screen, the amount of clutter should spread evenly throughout the depth of the water column.

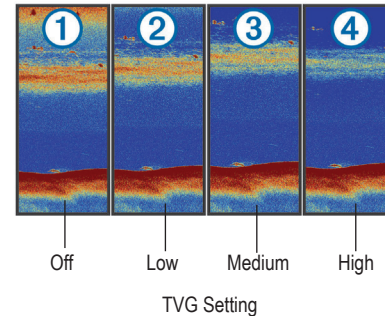

Overlay Numbers Settings

You can customize the data shown on the sonar screen.

From a sonar screen, select **MENU > Sonar Setup > Overlay Numbers**.

Navigation Inset: Shows the navigation inset when the vessel is navigating to a destination.

Compass Tape: Shows the compass tape data bar. **Device Voltage:** Shows the voltage of the device. **Depth:** Shows the transducer's current depth.

Speed: Shows the vessel's current speed.

Water Temp.: Shows the current water temperature.

Time of Day: Shows the current time of day.

Compass

The compass uses GPS course over ground (COG) to guide you to your destination, and does not account for other factors that can affect your destination, such as currents and tides.

Select **Navigation Info > Compass**.

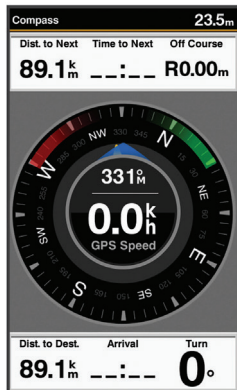

Depth and Water Temperature Graphs

If you are using a depth-capable transducer, or are receiving water depth information over NMEA 0183, you can view a graphic log of depth readings over time. If you are using a temperature-capable transducer, or are receiving water temperature information over NMEA 0183, you can view a graphic log of temperature readings over time.

The graphs scroll to the left as information is received.

Before you can view the depth data graph page or temperature graph page, you must add the page to your home screen (page 5). Select Depth Data

Graph or Temperature Data Graph

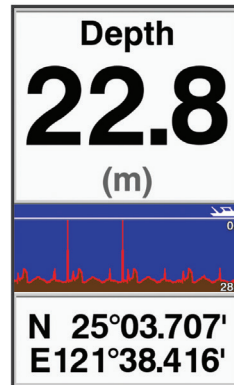

Charts and 3D Chart Views

The charts and 3D chart views that are available depend on the map data and accessories used.

You can add charts and 3D chart views to the home screen (page 5).

Navigation Chart: Shows navigation data available on your pre-loaded maps and from supplemental maps, if available. The data includes buoys, lights, cables, depth soundings, marinas, and tide stations in an overhead view.

Perspective 3D: Provides a view from above and behind the boat (according to your course) and provides a visual navigation aid. This view is helpful when navigating tricky shoals, reefs, bridges, or channels, and is beneficial when trying to identify entry and exit routes in unfamiliar harbors or anchorages.

Mariner's Eye 3D: Shows a detailed, three-dimensional view from above and behind the boat (according to your course) and provides a visual navigation aid. This view is helpful when navigating tricky shoals, reefs, bridges, or channels, and when trying to identify entry and exit routes in unfamiliar harbors or anchorages.

NOTE: Mariner's Eye 3D and Fish Eye 3D chart views are available with premium charts, in some areas.

Fish Eye 3D: Provides an underwater view that visually represents the sea floor according to the chart information. When a sonar transducer is connected, suspended targets (such as fish) are indicated by red, green, and yellow spheres. Red indicates the largest targets and green indicates the smallest.

Fishing Chart: Provides a detailed view of the bottom contours and depth soundings on the chart. This chart removes navigational data from the chart, provides detailed bathymetric data, and enhances bottom contours for depth recognition. This chart is best for offshore deep-sea fishing.

Navigation Chart and Offshore Fishing Chart

The Navigation and Fishing charts allow you to plan your course, view map information, and follow a route.







The Fishing chart is for offshore fishing.

Before you can open the navigation chart, you must add it to your home screen (page 5). To open the Navigation chart, select Navigation Chart.



Chart Symbols

This table contains some of the common symbols you might see on the detailed charts.

Icon	Description
	Buoy
	Information
	Marine services
	Tide station
	Current station
	Overhead photo available
	Perspective photo available

Other features common to most charts include depth contour lines, intertidal zones, spot soundings (as depicted on the original paper chart), navigational

aids and symbols, obstructions, and cable areas.

Viewing Location and Object Information on a Chart

You can view information about a location or an object on the Navigation chart or the Fishing chart.

- 1 From the Navigation chart or Fishing chart, select a location or object, and select **SELECT**.

A list of options appears. The options that appear vary based on the location or object you selected.

- 2 Select an option:

- To navigate to the selected location, select **Navigate To**.
- To mark a waypoint at the cursor location, select **Create Waypoint**.
- To view the distance and bearing of the object from your current location, select **Measure Distance**.
- To view tide, current, celestial, chart notes, or local services information near the cursor, select **Information**.

Navigating to a Point on the Chart



The Auto Guidance feature is based on electronic chart information. That data does not ensure obstacle and bottom clearance. Carefully compare the course to all visual sightings, and avoid any land, shallow water, or other obstacles that may be in your path.

When using Go To, a direct course and a corrected course may pass over land or shallow water. Use visual sightings, and steer to avoid land, shallow water, and other dangerous objects.

NOTE: The offshore Fishing chart is available with premium charts, in some areas.

NOTE: Auto Guidance is available with premium charts, in some areas.

- 1 From the Navigation chart or Fishing chart, select a location.
- 2 If necessary, select **SELECT**. You can select GOTO
- 3 Select **Navigate To**.
- 4 Select an option:
 - To navigate directly to the location, select **GOTO**.
 - To create a route to the location, including turns, select **Route To**.
 - To use Auto Guidance, select **Auto Guidance**.
- 5 Review the course indicated by the magenta line.

NOTE: When using Auto Guidance, a gray segment within any part of the magenta line indicates that Auto Guidance cannot calculate part of the Auto Guidance line. This is due to the settings for minimum safe water depth and minimum safe obstacle height.

- 6 Follow the magenta line, steering to avoid land, shallow water, and other obstacles.

Viewing Details about Nav aids

From the Navigation chart, Fishing chart, Perspective 3D chart view, or Mariner's Eye 3D chart view, you can view details about various types of navigation aids, including beacons, lights, and obstructions.

NOTE: The offshore Fishing chart is available with premium charts, in some areas.

NOTE: Mariner's Eye 3D and Fish Eye 3D chart views are available with premium charts, in some areas.

- 1 From a chart or 3D chart view, select a nav aid.
- 2 Select the name of the nav aid.

Chart and 3D Chart Settings

NOTE: Not all settings apply to all charts and 3D chart views. Some options require premium maps or connected accessories.

These settings apply to the charts and 3D chart views, except Fish Eye 3D (page 22).

From a chart or a 3D chart view, select **MENU**.

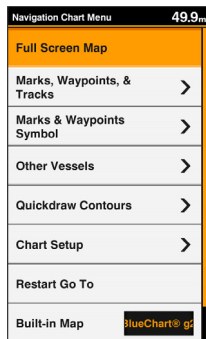

Full Screen Map: Displays the map on the full screen.

Marks, Waypoints, & Tracks: Opens marks, waypoints, and tracks lists (page 20).

Marks & Waypoints Symbol: Adjusts how the marks and waypoints symbols are shown.

Other Vessels: Adjusts how other vessels are shown (page 20).

Quickdraw Contours: Turns on bottom contour drawing, and allows you to create fishing map labels.

Chart Setup: Adjusts the appearance of the different charts and 3D chart views.

Marks, Waypoints, and Tracks on the Charts and Chart Views

From a chart or a 3D chart view, select **MENU > Marks, Waypoints, & Tracks**. **Tracks:** Shows tracks on the chart or 3D chart view.

Marks and Waypoints: Shows the list of marks and waypoints.

New Waypoint: Creates a new waypoint.

Active Tracks: Shows the active track options menu.

Saved Tracks: Shows the list of saved tracks.

Tracks Display: Sets which tracks to display on the chart based on track color.

Other Vessels on the Charts and Chart Views

NOTE: These options require connected accessories, such as an AIS receiver or VHF radio.

From a chart or 3D chart view, select **MENU > Other Vessels**.

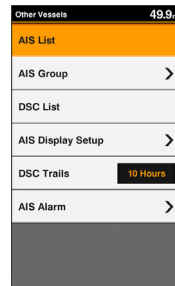

AIS List: Shows the AIS list (page 30).

AIS Group: Shows the AIS groups (page 21).

DSC List: Shows the DSC list (page 34).

AIS Display Setup: Allows you to set up the AIS display (page 21).

DSC Trails: Shows the tracks of DSC vessels, and selects the length of the track that appears using a trail.

AIS Alarm: Sets the safe-zone collision alarm (page 30).

AIS Display Setup

NOTE: AIS requires the use of an external AIS device and active transponder signals from other vessels.

From a chart or 3D chart view, select **MENU > Other Vessels > AIS Display Setup**.

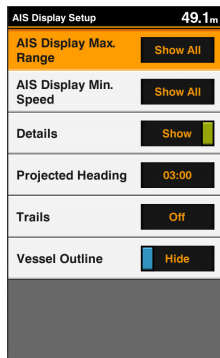

AIS Display Max. Range: Indicates the maximum distance from your location within which AIS vessels appear.

AIS Display Min. Speed: Indicates the minimum speed AIS vessels must travel to appear on your screen.

Details: Shows details about AIS vessels.

Projected Heading: Sets the projected heading time for AIS vessels.

Trails: Shows the tracks of AIS vessels, and select the length of the track that

appears using a trail.

Vessel Outline: Shows the outline of AIS vessels.

Navigation and Fishing Chart Setup

NOTE: Not all settings apply to all charts and 3D chart views. Some settings require external accessories or applicable premium charts.

From the Navigation chart or Fishing chart, select **MENU > Chart Setup**.

Tides & Currents: Shows tide station indicators on the chart and enables the tides, which sets the time for which tides are reported on the map.

Roses: Shows a compass rose around your boat, indicating compass direction oriented to the heading of the boat.

A true wind direction or apparent wind direction indicator appears if the chartplotter is connected to a compatible marine wind sensor. When in sailing mode, true and apparent wind are shown on the wind rose.

Overlay Numbers: See page 21.

Chart Appearance: See page 22.

Custom Maps: Shows customized maps.

Overlay Numbers

From a chart, 3D chart view, or a combinations screen, select **MENU > Chart Setup > Overlay Numbers > Show**.

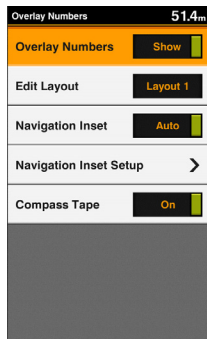

Edit Layout: Sets the layout of the data overlay, or data fields. You can select the data to be shown within each data field.

Navigation Inset: Shows the navigation inset when the vessel is navigating to a destination.

Navigation Inset Setup: Allows you to configure the navigation inset to show Route Leg Details, and to control when the inset appears before a turn or destination.

Compass Tape: Shows the compass tape data bar when the vessel is navigating to a destination.

Editing the Data Fields

You can change the data shown in the overlay numbers displayed on the charts and other screens.

- 1 From a screen that supports overlay numbers, select **MENU**.
- 2 If necessary, select **Chart Setup**.
- 3 Select **Overlay Numbers > Edit Layout**.
- 4 Select a layout.

5 Select a data field.

6 Select the type of data shown in the field.

Available data options vary based on the chartplotter and network configuration.

Showing a Navigation Inset

You can control whether a navigation inset appears on some chart views. The navigation inset is shown only when the boat is navigating to a destination.

- 1 From a chart or 3D chart view, select **MENU**.
- 2 If necessary, select **Chart Setup**.
- 3 Select **Overlay Numbers > Navigation Inset > Auto**.
- 4 Select **Navigation Inset Setup**.
- 5 Complete an action:
 - To show waypoint velocity made good (VMG) when navigating a route with more than one leg, select **Route Leg Details > On**.
 - To show next-turn data based on distance, select **Next Turn > Distance**.
 - To show next-turn data based on time, select **Next Turn > Time**.
 - To indicate how the destination data appears, select **Destination**, and select an option.

Chart Appearance Settings

You can adjust the appearance of the different charts and 3D chart views. Each setting is specific to the chart or chart view being used.

NOTE: Not all settings apply to all charts and 3D chart views and chartplotter models. Some options require premium maps or connected accessories.

From a chart or 3D chart view, select **MENU > Chart Setup > Chart**

Appearance.

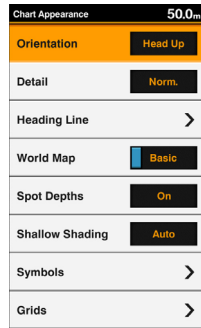

Orientation: Sets the perspective of the map.

Detail: Adjusts the amount of detail shown on the map, at different zoom levels.

Heading Line: Shows and adjusts the heading line, which is a line drawn on the map from the bow of the boat in the direction of travel, and sets the data source for the heading line.

World Map: Uses either a basic world map or a shaded relief map on the chart.
These differences are visible only when zoomed out too far to see the detailed charts.

Spot Depths: Turns on spot soundings and sets a dangerous depth. Spot depths that are equal to or more shallow than the dangerous depth are indicated by red text.

Shallow Shading: Sets the shades from the shoreline to the specified depth.

Symbols: Shows and configures the appearance of various symbols on the chart, such as the vessel icon, navaid symbols, land POIs, and light sectors.

Grids: Shows latitude and longitude grid lines, and fish grid lines.

Preferred Depth: Sets the appearance of a safe depth for the Mariner's Eye 3D chart view.

NOTE: This setting affects only the appearance of hazard colors for the Mariner's Eye 3D chart view. It does not affect the safe water depth Auto Guidance setting or the sonar shallow water alarm setting.

Range Rings: Shows and configures the appearance of range rings, which help you to visualize distances in some chart views.

Fish Eye 3D Settings

NOTE: This feature is available with premium charts, in some areas. From the Fish Eye 3D chart view, select MENU.

Fisheye View: Sets the perspective of the 3D chart view.

Tracks: Shows tracks.

Sonar Cone: Shows a cone that indicates the area covered by the transducer.

Fish Symbols: Shows suspended targets.

Garmin Quickdraw™ Contours Mapping



The Garmin Quickdraw Contours mapping feature allows users to generate maps. Garmin makes no representations about the accuracy, reliability, completeness or timeliness of the maps generated by third parties. Any use or reliance on the maps generated by third parties is at your own risk.

The Garmin Quickdraw Contours mapping feature allows you to instantly create maps with contours and depth labels for any body of water.

When Garmin Quickdraw Contours records data, a colored circle surrounds the vessel icon. This circle represents the approximate area of the map that is

scanned by each pass.

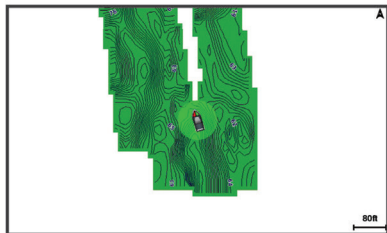

A green circle indicates good depth and GPS position, and a speed under 16 km/h (10 mph). A yellow circle indicates good depth and GPS position, and a speed between 16 and 32 km/h (10 and 20 mph). A red circle indicates poor depth or GPS position, and a speed above 32 km/h (20 mph).

You can view Garmin Quickdraw Contours in a combination screen or as a single view on the map.

The amount of saved data depends on the size of your memory card, your sonar source, and the speed of your boat as you record data. You can record longer when you use a single-beam sonar. It is estimated that you might be able to record about 1,500 hours of data onto a 2 GB memory card.

When you record data on a memory card in your chartplotter, the new data is added to your existing Garmin Quickdraw Contours map, and is saved on the memory card. When you insert a new memory card, the existing data does not transfer onto the new card.

Mapping a Body of Water Using the Garmin Quickdraw Contours Feature

Before you can use the Garmin Quickdraw Contours feature, you must have a supported chartplotter with upgraded software, sonar depth, your GPS

position, and a memory card with free space.

NOTE: This feature is not available on all models.

- 1 From a chart view, select **MENU > Quickdraw Contours > Start Recording**.
- 2 When recording is complete, select **Stop Recording**.
- 3 Select **Manage > Name**, and enter a name for the map.

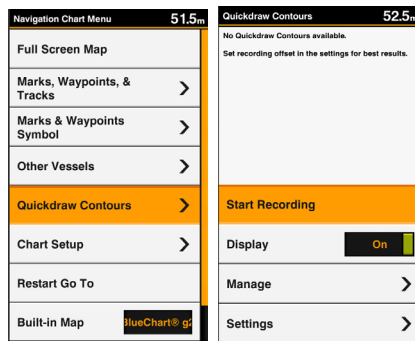

Garmin Quickdraw Contours Map Manage

You can manage your Garmin Quickdraw Contours map from the Manage Quickdraw menu.

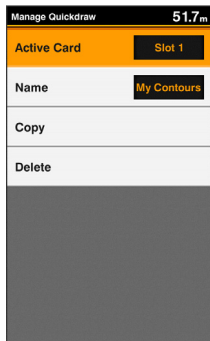

- 1 Select the SD memory card slot in **Active Card** to record the Quickdraw mapping data.
- 2 Select **Name** to change the Quickdraw map's file name.
- 3 Select **Copy** to copy the Quickdraw map file by select.
- 4 Select **Delete** to delete the Quickdraw map file.

Garmin Quickdraw Contours Settings

You can adjust the display and offset of Quickdraw Contours. From a chart, select **MENU > Quickdraw Contours > Settings**.

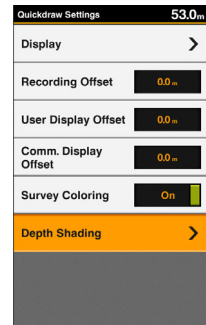

Display: Displays Garmin Quickdraw Contours. The User Contours option shows your own Garmin Quickdraw Contours maps. The Community Contours option shows maps you downloaded from the Garmin Quickdraw Community.

Recording Offset: Sets the difference between the sonar depth and the contour recording depth. If the water level has changed since your last recording, adjust this setting so the recording depth is the same for both recordings.

For example, if the last time you recorded had a sonar depth of 3.1 m (10.5 ft.), and today's sonar depth is 3.6 m (12 ft.), set the Recording Offset as -0.5 m (-1.5 ft.).

User Display Offset: Sets the difference between the contour depths and the depth labels on your own contours maps to compensate for changes in the water level of a body of water, or for depth errors in recorded maps.

Comm. Display Offset: Sets the difference between the contour depths and the depth labels on the community contours maps to compensate for changes in the water level of a body of water, or for depth errors in recorded maps.

Survey Coloring: Sets the color of the Garmin Quickdraw Contours display.

When this setting is turned on, the colors indicate the quality of the recording. When this setting is turned off, the contour areas use standard map colors.

Green indicates good depth and GPS position, and a speed under 16 km/h (10 mph). Yellow indicates good depth and GPS position, and a speed between 16 and 32 km/h (10 and 20 mph). Red indicates poor depth or GPS position, and a speed above 32 km/h (20 mph).

Depth Shading: Specifies the upper and lower limits of a depth range and a color for that depth range.

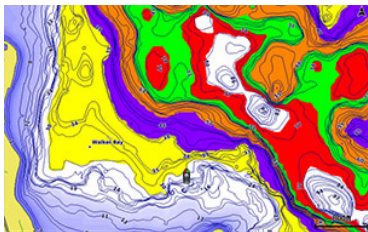

Adding a Label to a Garmin Quickdraw Contours Map

You can add labels to a Garmin Quickdraw Contours map to mark hazards or points of interest.

- 1 From the Navigation chart, select a location.
- 2 Select **Add Quickdraw Label**.
- 3 Enter text for the label, and select **SELECT**.

Garmin Quickdraw Community

The Garmin Quickdraw Community is a free, public, online community that enables you to share your Garmin Quickdraw Contours maps with others. You can also download maps other users have created.

To access the Garmin Quickdraw Community, sign in to your Garmin Connect™ account, and then you can upload and download maps using a memory card.

Accessing the Garmin Quickdraw Community

You can access the Garmin Quickdraw Community using Garmin Connect website.

- 1 Go to connect.garmin.com.
- 2 Select **Get Started > Quickdraw Community > Get Started**.
- 3 If you do not have a Garmin Connect account, create one.
- 4 Sign in to your Garmin Connect account.
- 5 Select **Marine** in the upper-right to open the Garmin Quickdraw widget.

TIP: Make sure you have a memory card in your computer to share Garmin Quickdraw Contours maps.

Sharing Your Garmin Quickdraw Contours Maps with the Garmin Quickdraw Community

You can share Garmin Quickdraw Contours maps that you have created with others in the Garmin Quickdraw Community.

When you share a contour map, only the contour map is shared. Your waypoints are not shared.

- 1 Remove the memory card from the chartplotter.
- 2 Insert the memory card into your computer.
- 3 Access the Garmin Quickdraw Community (page 23).
- 4 Select **Share Your Contours**.
- 5 Browse to your memory card, and select the /Garmin folder.
- 6 Open the /Quickdraw folder, and select the file named ContoursLog.svy.

After the file is uploaded, delete the ContoursLog.svy file from your memory card to avoid issues with future uploads. Your data will not be lost.

Downloading Garmin Quickdraw Community Maps

You can download Garmin Quickdraw Contours maps that other users have created and shared with the Garmin Quickdraw Community.

- 1 Insert the memory card into your computer.
- 2 Access the Garmin Quickdraw Community (page 23).
- 3 Select **Search for Contours**.
- 4 Use the map and search features to locate an area to download.
The red dots represent Garmin Quickdraw Contours maps that have been shared for that region.

- 5 Select **Select an Area to Download**.

- 6 Drag the edges of the box to select the area to download.

- 7 Select **Start Download**.

- 8 Save the file to your memory card.

TIP: If you cannot find the file, look in the “Downloads” folder. The browser may have saved the file there.

- 9 Remove the memory card from your computer.

- 10 Insert the memory card in the chartplotter.

The chartplotter automatically recognizes the contours maps. The chartplotter may take a few minutes to load the maps.

Waypoints and Marks

Waypoints are locations you record and store in the device that allow you to navigate back to a location. Waypoints display on the screen as a blue flag, and include the waypoint name and symbol.

Marks are locations you record without navigation information. Marks display on the screen as a dot with a symbol, and are hidden in the Waypoints and Marks list by default. When you transfer a mark to another device, the mark is converted to a waypoint.

You can save a maximum of 12,000 waypoints and marks.

Creating a Mark or Waypoint on a Sonar Screen Using Your Present Location

- 1 Pause the sonar.
- 2 Select an option:
 - To create a mark at the cursor, select **MARK/WPT**.
 - To create a waypoint at the cursor, hold **MARK/WPT**.
 - To create a mark at your boat position, with the cursor invisible and no menu shown, select **MARK/WPT**.
 - To create a waypoint at your boat position, with the cursor invisible and no menu shown, select **MARK/WPT**.
- 3 If necessary, edit the mark or waypoint information.

Creating a Waypoint on a Sonar Screen Using a Different Location

- 1 Select ◀ or ▶ to pause the sonar.
- 2 Using the arrow keys, select a location.
- 3 Select an option:
 - To create a mark, select **MARK**.
 - To create a waypoint, hold **MARK**.
- 4 If necessary, edit the mark or waypoint information.

Creating a Mark or Waypoint

- 1 Select an option:
 - To create a mark at the cursor, select **MARK/WPT**.
 - To create a waypoint at the cursor, hold **MARK/WPT**.
 - To create a mark at your boat position, with the cursor invisible and no menu shown, select **MARK/WPT**.
 - To create a waypoint at your boat position, with the cursor invisible and no menu shown, select **MARK/WPT**.
- 2 If necessary, edit the mark or waypoint information.

Editing a Saved Waypoint

- 1 Select **User Data > Waypoints**.
- 2 Select a waypoint.
- 3 Select **Edit Waypoint**.
- 4 Select an option:
 - To add a name, select **Name**, and enter a name.
 - To change the symbol, select **Symbol**.

- To change the depth, select **Depth**.
- To change the water temperature, select **Water Temp.**
- To change the comment, select **Comment**.
- To move the position of the waypoint, select **Position**.

Marking and Navigating to a Man Overboard Location

From any screen, select **MARK > Man Overboard > Yes**. The fishfinder sets a direct course back to the location.

Navigating to a Waypoint

- 1 Pan the waypoint map to find the waypoint.
- 2 Place the center of the cursor on the center of the waypoint symbol. The waypoint name appears on the screen.
- 3 Select the waypoint.
- 4 Select **Navigate To > Go To**.

Measuring Distance on the Waypoint Map

You can measure the distance between two locations.

- 1 From the waypoint map, begin panning .
- 2 Select **SELECT > Measure Distance**.
The distance and other data appear on the screen.

Deleting a Waypoint or an MOB

- 1 Select **User Data > Waypoints**.
- 2 Select a waypoint or an MOB.
- 3 Select **Delete > OK**.

Deleting All Waypoints

Select **User Data > Manage Data > Clear User Data > Waypoints > All**.

Copying Waypoints, Routes, and Tracks to a Memory Card

- 1 Insert a memory card into the card slot.
- 2 Select **User Data > Manage Data > Data Transfer > Save to Card**.
- 3 If necessary, select the memory card to copy data to.
- 4 Select an option:
 - To create a new file, select **Add New File**, and enter a name. The file name is saved with an .adm extension.
 - To add the information to an existing file, select the file from the list.

Sharing Waypoints and Routes Across Devices

Before you can share waypoints and routes, you must connect the devices using a data sharing cable. The data sharing cable is an accessory you can purchase.

You can share waypoint and route data between two compatible chartplotters installed on your boat. You must turn on user data sharing for both devices to share data.

Select **User Data > Manage Data > User Data Sharing > On** on both devices.

User Data Settings

Select **User Data**.

Marks/Waypoints: Shows the list of marks and waypoints.

Tracks: Shows the track option menu.

Routes & Auto Guidance Paths: Shows the list of routes.

Proximity Waypoint: Shows the list of particular locations within a specified range.

Boundaries: Shows the list of marked legal, safety, or geographical boundaries.

Search by Name: Allows you to search for saved routes, tracks, and waypoints by name.

Manage Data: Shows memory usage, and allows you to clear data for routes, tracks, waypoints, and boundaries.

Routes

A route is a sequence of waypoints or locations that leads you to your final destination.

Creating and Navigating a Route Using the Waypoint Map

The starting point can be your present location or another location.

- 1 Select **User Data > Routes & Auto Guidance Paths > New > Route Using Chart**.

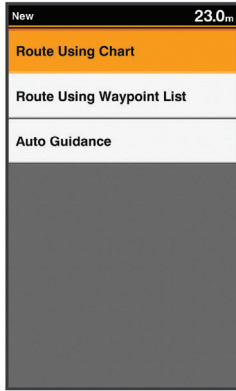

- 2 Pan the waypoint map to select the starting location of the route.
- 3 Follow the onscreen instructions to add a turns.
- 4 Select **MENU > Navigate To**.
- 5 Select an option.

Creating and Navigating a Route Using the Waypoint Map

The starting point can be your present location or another location.

- 1 Select **User Data > Routes & Auto Guidance Paths > New > Route Using Chart**.
- 2 Pan the waypoint map to select the starting location of the route.
- 3 Follow the onscreen instructions to add a turns.
- 4 Select **MENU > Navigate To**.

- 5 Select an option.

Creating and Navigating a Route Using the Waypoint List

- 1 Select **User Data > Routes & Auto Guidance Paths > New > Route Using Waypoint List**.
- 2 Select waypoints.
- 3 Select **BACK > Navigate To**.

Editing a Saved Route

You can change the name of a route or change the turns the route contains.

- 1 Select **User Data > Routes & Auto Guidance Paths**.
- 2 Select a route.
- 3 Select **Edit Route**.
- 4 Select an option:
 - To change the name, select **Name**, and enter the name.
 - To select a waypoint from the turn list, select **Edit Turns > Use Turn List**, and select a waypoint from the list.
 - To select a turn using the chart, select **Edit Turns > Route Using Chart**, and select a location on the chart.

Viewing a List of Routes

Select **User Data > Routes & Auto Guidance Paths**.

Browsing for and Navigating a Saved Route

Before you can browse a list of routes and navigate to one of them, you must create and save at least one route.

- 1 Select **User Data > Routes & Auto Guidance Paths**.
- 2 Select a route.
- 3 Select **Navigate To**.
- 4 Select an option:
 - To navigate the route from the starting point used when the route was created, select **Forward**.
 - To navigate the route from the destination point used when the route was created, select **Backward**.

A magenta line appears. In the center of the magenta line is a thinner purple line that represents the corrected course from your present location to the destination. The corrected course is dynamic, and it moves with your boat when you are off course.

- 5 Review the course indicated by the magenta line.
- 6 Follow the magenta line along each leg in the route, steering to avoid land, shallow water, and other obstacles.
- 7 If you are off course, follow the purple line (corrected course) to go to your destination, or steer back to the magenta line (direct course).

Deleting a Saved Route

- 1 Select **User Data > Routes & Auto Guidance Paths**.
- 2 Select a route.
- 3 Select **Delete**.

Deleting All Saved Routes

Select **User Data > Manage Data > Clear User Data > Routes & Auto Guidance Paths**.

Track

A track is a recording of the current path of your boat. You can show your current track in waypoint map view.

Setting the Color of the Track

- 1 Select **User Data > Tracks > Active Track Options > Track Color**.
- 2 Select a track color.

Clearing the Track

Select **User Data > Tracks > Clear Active Track > OK**.

Managing the Track Log Memory During Recording

- 1 Select **User Data > Tracks > Active Track Options**.
- 2 Select **Record Mode**.
- 3 Select an option:
 - To record a track log until the track memory is full, select **Fill**.
 - To continuously record a track log, replacing the oldest track data with new data, select **Wrap**.

Configuring the Recording Interval of the Track Log

You can indicate the frequency at which the track plot is recorded. Recording more frequent plots is more accurate but fills the track log faster. The

resolution interval is recommended for the most efficient use of memory.

1 Select **User Data > Tracks > Active Track Options > Record Interval > Interval**.

2 Select an option:

- To record the track based on a distance between points, select **Distance > Change**, and enter the distance.
- To record the track based on a time interval, select **Time > Change**, and enter the time interval.
- To record the track plot based on a variance from your course, select **Resolution > Change**, and enter the maximum error allowed from the true course before recording a track point.

Deleting All Saved Waypoints, Routes, and Tracks

Select **User Data > Manage Data > Clear User Data > All > OK**.

AIS Radar

The Automatic Identification System (AIS) enables you to identify and track other vessels, and alerts you to area traffic.

When connected to an external AIS device, the chartplotter can show some AIS information about other vessels that are within range, equipped with a transponder, and are actively transmitting AIS information. The information reported for each vessel includes the Maritime Mobile Service Identity (MMSI), location, GPS speed, GPS heading, time that has elapsed since the last position of the vessel was reported, nearest approach, and time to the nearest approach.

The AIS Radar screen provides a pictorial representation of the AIS vessels around you, similar to a radar display, and a list of those vessels.

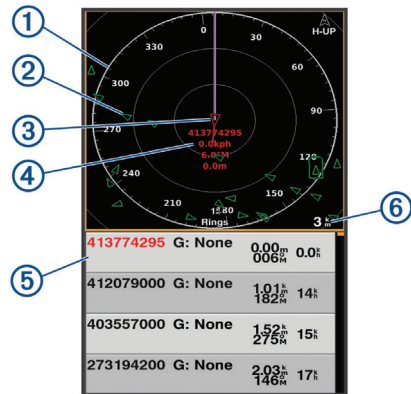

①	Bearing ring
②	Target in the safe range
③	Active target
④	Active target Maritime Mobile Service Identity (MMSI) and details
⑤	AIS targets list
⑥	Range

Adjusting the AIS Radar Range

- Select **—** to decrease the range.
- Select **+** to increase the range.

Marking a Waypoint on the AIS Radar Screen

- 1 From the **AIS Radar** screen, use the arrow keys to select a location.
- 2 Select **MARK**.

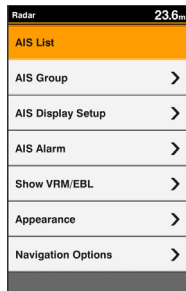

Viewing a List of AIS Threats

From the AIS Radar screen, you can view and customize the appearance of a list of AIS threats.

From the **AIS Radar** screen, select **MENU > AIS List**.

Creating an AIS Group

An AIS group is a collection of specific vessels, such as a sailing club or flotilla.

- 1 From the **AIS Radar** screen, select **MENU > AIS Group**.
- 2 Select a group.
- 3 Select AIS vessels.
- 4 Select **SELECT**.

Customizing the Display of the AIS Radar Screen

You can configure how other vessels appear on the AIS Radar screen.

- 1 From the **AIS Radar** screen, select **MENU > AIS Display Setup**.

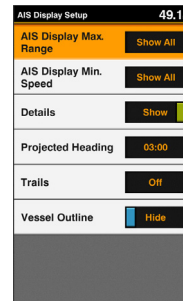

- 2 Select an option:
 - To set the maximum distance of AIS vessels to display, select **AIS Display Max. Range**.
 - To set the minimum speed of AIS vessels to display, select **AIS Display Min. Speed**.
 - To show details about AIS-activated vessels, select **Details > Show**.
 - To set the projected heading time for AIS-activated vessels, select **Projected Heading**.
 - To show the tracks of AIS-activated vessels, select **Trails**.
 - To show the outlines of AIS vessels, select **Vessel Outline**.

Enabling AIS Transmission Test Alerts

To avoid a large number of test alerts and symbols in crowded areas such as marinas, you can select to receive or ignore AIS test messages. To test an

AIS emergency device, you must enable the chartplotter to receive test alerts.

1 From the **AIS Radar** screen, select **MENU > AIS Alarm**.

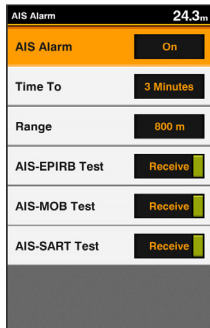

2 Select an option:

- To receive or ignore Emergency Position Indicating Radio Beacon (EPRIB) test signals, select **AIS-EPIRB Test**.
- To receive or ignore Man Overboard (MOB) test signals, select **AIS-MOB Test**.
- To receive or ignore Search and Rescue Transponder (SART) test signals, select **AIS-SART Test**.

Setting the Safe-Zone Collision Alarm

The safe-zone collision alarm is used only with AIS. The safe zone is used for collision avoidance, and can be customized.

1 From the **AIS Radar** screen, select **MENU > AIS Alarm**.

2 Select **AIS Alarm > On**.

When the AIS alarm is turned off, the message banner and audible alarm are disabled, but the object is still labeled as dangerous on the screen.

3 Select **Range**.

4 Select a distance for the safe-zone radius around your vessel.

5 Select **Time To**.

6 Select a time at which the alarm will sound if a target is determined to intersect the safe zone.

For example, to be notified of a pending intersection 10 minutes before it will likely occur, set Time To to 10, and the alarm will sound 10 minutes before the vessel intersects the safe zone.

A message banner appears and an alarm sounds when an AIS-activated vessel enters the safe-zone area around your boat. The object is also labeled as dangerous on the screen. When the alarm is off, the message banner and audible alarm are disabled, but the object is still labeled as dangerous on the screen.

VRM and EBL

The variable range marker (VRM) and electronic bearing line (EBL) measure the distance and bearing from your boat to a target object.

On the AIS Radar screen, the VRM appears as a circle that is centered on the present location of your boat, and the EBL appears as a line that begins at the present location of your boat and intersects the VRM. The point of intersection is the target of the VRM and EBL.

Showing the VRM and EBL

From the **AIS Radar** screen, select **MENU > Show VRM/EBL**.

Adjusting the VRM and EBL

Before you can adjust the VRM and EBL, you must show them (page 31).

You can adjust the diameter of the VRM and the angle of the EBL, which moves the intersection point of the VRM and the EBL.

- 1 From the **AIS Radar** screen, select **MENU > Adjust VRM/EBL > Move VRM/ EBL**.
- 2 Use the arrow keys to adjust the VRM and EBL.
- 3 Select **SELECT**.

Measuring the Range and Bearing to a Target Object

- 1 From the **AIS Radar** screen, select the target location.
- 2 Select **SELECT > Measure Distance**.
The range and the bearing to the target location appear.
- 3 If necessary, use the arrow keys to move the target to a new location.
- 4 Select **BACK**.

AIS Radar Appearance Settings

From the AIS Radar screen, select **MENU > Appearance**.

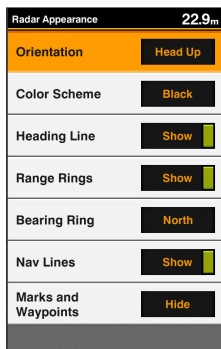

Orientation: Sets the perspective of the AIS Radar screen.

Color Scheme: Sets the color scheme for the AIS Radar screen.

Heading Line: Shows an extension from the bow of the boat in the direction of travel on the AIS Radar screen.

Range Rings: Shows the range rings that help you to visualize distances on the AIS Radar screen.

Bearing Ring: Shows a bearing relative to your heading or based on a north reference, to help you determine the bearing to an object shown on the AIS Radar screen.

Nav Lines: Shows the navigation lines that indicate the course you have set using Route To, Auto Guidance, or Go To.

Marks/Waypoints: Shows waypoints on the AIS Radar screen.

Highway Page

The highway page provides steering guidance as you navigate to your destination. The graphic highway display shows each route waypoint in sequence. The line down the center of the highway represents your preferred track line. You can customize the page layout and data fields.

Opening the Highway Page

Before you can use the Highway page, you must be navigating to a destination.



The highway feature is based on electronic chart information. That data does not ensure obstacle and bottom clearance. Carefully compare the course to all visual

sightings, and avoid any land, shallow water, or other obstacles that may be in your path.

From the home screen, select **Highway**.

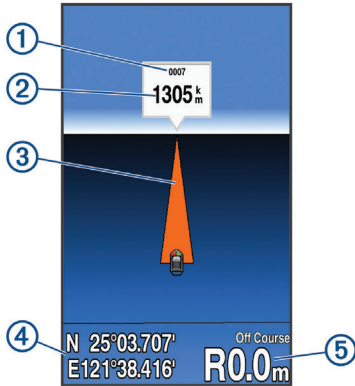

①	Mark or waypoint
②	Distance to destination
③	Track line
④	Coordinates
⑤	Distance off course

Showing and Customizing the Highway Overlay Numbers

You can customize the data shown on the screen.

- 1 From the Highway screen, select **MENU > Overlay Numbers > Show**.
- 2 Select **Edit Layout**.
- 3 Using **+** and **-**, select a layout.

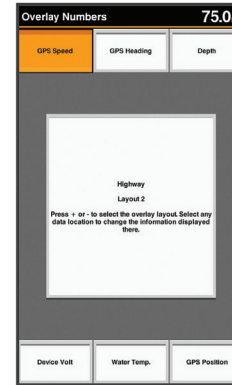

- 4 Select an overlay box.
- 5 Select the data to show.
- 6 Select **BACK**.

Auto Guidance



The Auto Guidance feature is based on electronic chart information. That data does not ensure obstacle and bottom clearance. Carefully compare the course to all visual sightings, and avoid any land, shallow water, or other obstacles that may be in your path.

NOTE: Auto Guidance is available with premium charts, in some areas. You can use Auto Guidance to plot the best path to your destination. Auto Guidance uses your chartplotter to scan chart data, such as water depth and known obstacles, to calculate a suggested path. You can adjust the path

during navigation.

Auto Guidance Path Configurations

⚠ CAUTION

The Preferred Depth and Safe Height settings influence how the chartplotter calculates an Auto Guidance path. If an area has an unknown water depth or an unknown obstacle height, the Auto Guidance path is not calculated in that area. If an area at the beginning or the end of an Auto Guidance path is shallower than the Preferred Depth or lower than the Safe Height settings, the Auto Guidance path may not be calculated in that area, depending on the map data. On the chart, the course through those areas appears as a gray line or a magenta and gray striped line. When your boat enters one of those areas, a warning message appears.

NOTE: Auto Guidance is available with premium charts, in some areas.

NOTE: Not all settings apply to all maps.

You can set the parameters the chartplotter uses when calculating an Auto Guidance path.

Preferred Depth: Sets the minimum water depth, based on chart depth data, that your boat can safely travel over.

NOTE: The minimum water depth for the premium charts (made before 2016) is 3 feet. If you enter a value of less than 3 feet, the charts only use depths of 3 feet for Auto Guidance path calculations.

Safe Height: Sets the minimum height of a bridge or obstacle, based on chart data, that your boat can safely travel under.

Shoreline Distance: Sets how close to the shore you want the Auto Guidance path to be placed. The Auto Guidance path may move if you change this setting while navigating. The available values for this setting are relative, not absolute. To ensure that the Auto Guidance line is placed

the appropriate distance from shore, you can assess the placement of the Auto Guidance path using one or more familiar destinations that require navigation through a narrow waterway (page 33).

Adjusting the Distance from Shore

⚠ CAUTION

The Auto Guidance feature is based on electronic chart information. That data does not ensure obstacle and bottom clearance. Carefully compare the course to all visual sightings, and avoid any land, shallow water, or other obstacles that may be in your path.

NOTE: Auto Guidance is available with premium charts, in some areas.

The Shoreline Distance setting indicates how close to the shore you want the Auto Guidance line to be placed. The Auto Guidance line may move if you change this setting while navigating. The available values for the Shoreline Distance setting are relative, not absolute. To ensure the Auto Guidance line is placed the appropriate distance from shore, you can assess the placement of the Auto Guidance line using one or more familiar destinations that require navigation through a narrow waterway.

- 1 Dock your vessel or drop the anchor.
- 2 Select **Settings > Navigation > Auto Guidance > Shoreline Distance > Normal**.
- 3 Select a destination that you have navigated to previously.
- 4 Select **Navigate To > Guide To**.
- 5 Review the placement of the Auto Guidance line, and determine whether the line safely avoids known obstacles and the turns enable efficient travel.
- 6 Select an option:
 - If the placement of the Auto Guidance line is satisfactory, select **MENU > Stop Navigation**, and proceed to step 10.

- If the Auto Guidance line is too close to known obstacles, select **Settings > Navigation > Auto Guidance > Shoreline Distance > Far**.
 - If the turns in the Auto Guidance line are too wide, select **Settings > Navigation > Auto Guidance > Shoreline Distance > Near**.
- 7 If you selected **Near** or **Far** in step 6, review the placement of the Auto Guidance line, and determine whether the line safely avoids known obstacles and the turns enable efficient travel.

Auto Guidance maintains a wide clearance from obstacles in open water, even if you set the Shoreline Distance setting to Near or Nearest. As a result, the chartplotter may not reposition the Auto Guidance line, unless the destination selected requires navigation through a narrow waterway.

- 8 Select an option:
- If the placement of the Auto Guidance line is satisfactory, select **MENU > Stop Navigation**, and proceed to step 10.
 - If the Auto Guidance line is too close to known obstacles, select **Settings > Navigation > Auto Guidance > Shoreline Distance > Farthest**.
 - If the turns in the Auto Guidance line are too wide, select **Settings > Navigation > Auto Guidance > Shoreline Distance > Nearest**.
- 9 If you selected **Nearest** or **Farthest** in step 8, review the placement of the Auto Guidance line, and determine whether the line safely avoids known obstacles and the turns enable efficient travel.

Auto Guidance maintains a wide clearance from obstacles in open water, even if you set the Shoreline Distance setting to Near or Nearest. As a result, the chartplotter may not reposition the Auto Guidance line, unless the destination selected requires navigation through a narrow waterway.

- 10 Repeat steps 3 through 9 at least once more, using a different destination each time, until you are familiar with the functionality of the Shoreline

Digital Selective Calling

Networked Chartplotter and VHF Radio Functionality

If you have a NMEA 0183 VHF radio connected to your chartplotter, these features are enabled.

- The chartplotter can transfer your GPS position to your radio. If your radio is capable, GPS position information is transmitted with DSC calls.
- The chartplotter can receive digital selective calling (DSC) distress and position information from the radio.
- The chartplotter can track the positions of vessels sending position reports.

Turning On DSC

Select **Settings > Other Vessels > DSC**.

DSC List

The DSC list is a log of the most recent DSC calls and other DSC contacts you have entered. The DSC list can contain up to 100 entries. The DSC list shows the most recent call from a boat. If a second call is received from the same boat, it replaces the first call in the call list.

Viewing the DSC List

Before you can view the DSC list, the chartplotter must be connected to a VHF radio that supports DSC.

Select **Navigation Info > Other Vessels > DSC List**.

Adding a DSC Contact

You can add a vessel to your DSC list. You can make calls to a DSC contact from the chartplotter.

- 1 Select **Navigation Info > Other Vessels > DSC List > Add Contact**.
- 2 Enter the Maritime Mobile Service Identity (MMSI) of the vessel.
- 3 Enter the name of the vessel.

Incoming Distress Calls

If your compatible chartplotter and VHF radio are connected using NMEA 0183, your chartplotter alerts you when your VHF radio receives a DSC distress call. If position information was sent with the distress call, that information is also available and recorded with the call.

 designates a distress call in the DSC list and marks the position of the vessel on the Navigation chart at the time of the DSC distress call.

Navigating to a Vessel in Distress

 designates a distress call in the DSC list and marks the position of a vessel on the Navigation chart at the time of the DSC distress call.

- 1 Select **Navigation Info > Other Vessels > DSC List**.
- 2 Select a position-report call.
- 3 Select **Navigate To**.
- 4 Select **Go To** or **Route To**.

Position Tracking



When you connect the chartplotter to a VHF radio using NMEA 0183, you can track vessels that send position reports.

Every position report call received is logged in the DSC list (page 34).

Viewing a Position Report

- 1 Select **Navigation Info > Other Vessels > DSC List**.
- 2 Select a position-report call.

3 Select an option:

- To switch to position report details, select .
- To switch to a Navigation chart marking the location, select .
- To switch to a Navigation chart marking the location, select **Next Page**.
- To view the position report details, select **Previous Page**.

Navigating to a Tracked Vessel

- 1 Select **Navigation Info > Other Vessels > DSC List**.
- 2 Select a position-report call.
- 3 Select **Navigate To**.
- 4 Select **Go To** or **Route To**.

Creating a Waypoint at the Position of a Tracked Vessel

- 1 Select **Navigation Info > Other Vessels > DSC List**.
- 2 Select a position-report call.
- 3 Select **Create Waypoint**.

Editing Information in a Position Report

- 1 Select **Navigation Info > Other Vessels > DSC List**.
- 2 Select a position-report call.
- 3 Select **Edit**.
 - To enter the name of the vessel, select **Name**.
 - To select a new symbol, select **Symbol**, if available.
 - To enter a comment, select **Comment**.
 - To show a trail line for the vessel if your radio is tracking the position of the vessel, select **Trail**.

- To select a color for the trail line, select **Trail Line**.

Deleting a Position-Report Call

- 1 Select **Navigation Info > Other Vessels > DSC List**.
- 2 Select a position-report call.
- 3 Select **Edit > Clear Report**.

Viewing Vessel Trails on the Chart

You can view trails for all tracked vessels on some chart views. By default, a black line indicates the path of the vessel, a black dot indicates each previously reported position of a tracked vessel, and a blue flag indicates the last reported position of the vessel.

- 1 From a chart or 3D chart view, select **MENU > Other Vessels > DSC Trails**.
- 2 Select the number of hours to show tracked vessels on the chart.

For example, if you select 4 Hours, all trail points that are less than four hours old appear for all tracked vessels.

Individual Routine Calls

When you connect the chartplotter to a Garmin VHF radio, you can use the chartplotter interface to set up an individual routine call.

When setting up an individual routine call from your chartplotter, you can select the DSC channel on which you want to communicate. The radio transmits this request with your call.

Selecting a DSC Channel

NOTE: The selection of a DSC channel is limited to those channels that are available in all frequency bands. The default channel is 72. If you select a different channel, the chartplotter uses that channel for subsequent calls until

you call using another channel.

- 1 Select **Navigation Info** > **Other Vessels** > **DSC List**.
- 2 Select a vessel or a station to call.
- 3 Select **Call With Radio** > **Channel**.
- 4 Select an available channel.

Making an Individual Routine Call

NOTE: When initiating a call from the chartplotter, if the radio does not have an MMSI number programmed, the radio will not receive call information.

- 1 Select **Navigation Info** > **Other Vessels** > **DSC List**.
- 2 Select a vessel or a station to call.
- 3 Select **Call With Radio**.
- 4 If necessary, select **Channel**, and select a new channel.
- 5 Select **Send**.

The chartplotter sends information about the call to the radio.

- 6 On your Garmin VHF radio, select **Call**.

Making an Individual Routine Call to an AIS Target

- 1 From a chart or 3D chart view, select an AIS target.
- 2 Select **AIS Vessel** > **Call With Radio**.
- 3 If necessary, select **Channel**, and select a new channel.
- 4 Select **Send**.

The chartplotter sends information about the call to the radio.

- 5 On your Garmin VHF radio, select **Call**.

Tide, Current, Lunar Calendar, and Celestial Information

Celestial Information

You can view information about sunrise, sunset, moonrise, moonset, moon phase, and the approximate sky view location of the sun and moon. The center of the screen represents the sky overhead, and the outermost rings represent the horizon. By default, the chartplotter shows celestial information for the present date and time.

Select **Navigation Info** > **Tides & Currents** > **Celestial**.

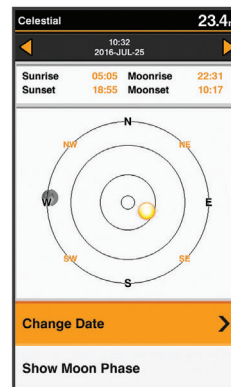

Viewing Information for a Different Tide Station

- 1 Select **Navigation Info** > **Tides & Currents**.
- 2 Select **Tides** or **Currents**.

3 Select **Nearby Stations**.

4 Select a station.

Lunar Calendar

You can view information about moonrise, moonset, and moon phases in calendar form.

Select **Navigation Info > Tides & Currents > Lunar Calendar**.





Device Configuration

GPSMAP 585 Plus Settings Menu Tree

- System
 - Display
 - Backlight

- Color Mode
- Configure Colors
- Beeper
 - GPS
 - Skyview
 - GPS Mode
 - SBAS
 - Speed Filter
- Auto Power
 - Off
 - On
- Language
- System Information
 - Event Log
 - Software Information
 - Factory Settings
- Simulator
- My Vessel
 - Keel Offset
 - Temp. Offset
 - Calibrate Water Speed
- Communications
 - Serial Port
 - NMEA 0183 Setup
 - Sounder

- Route
- System
- Garmin
- Posn Precision
- XTE Precision
- Waypoint IDs
- MMSI
- Diagnostics
- Defaults
- Alarms
 - Navigation
 - Arrival
 - Type
 - Activation
 - Change Time
 - Anchor Drag
 - Off Course
 - System
 - Alarm Clock
 - Device Voltage
 - GPS Accuracy
 - Sonar
 - Shallow Water
 - Deep Water
 - Water Temp.
- Fish
- Off
 - 
 - 
 - 
- AIS
- AIS Alarm
- Time To
- Range
- AIS-EPIRB Test
- AIS-MOB Test
- AIS-SART Test
- Units
 - System Units
 - Variance
 - North Reference
 - Position Format
 - Map Datum
 - Time Format
 - Time Zone
- Navigation
 - Route Labels
 - Auto Guidance
 - Turn Transition Activation
 - Turn Transition Time

- Route Start
- Other Vessels
 - AIS
 - DSC
 - AIS Alarm
 - AIS Alarm
 - Time To
 - Range
 - AIS-EPIRB Test
 - AIS-MOB Test
 - AIS-SART Test

System Settings

Select **Settings > System**.

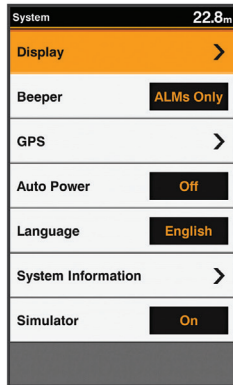

Display: Adjusts the backlight brightness (page 3) and color scheme (page 4).

Beeper: Turns on and off the tone that sounds for alarms and selections (page 4).

GPS: Provides information about the GPS satellite settings and fix, and allows you to select a GPS system.

Auto Power: Turns on the device automatically when power is applied.

Language: Sets the on-screen language.

System Information: Provides information about the device and the software version.

Simulator: Turns on the simulator and allows you to set the speed and simulated location.

System Information

Select **Settings > Settings > System Information**. **Event Log:** Allows you to view a log of system events.

Software Information: Provides information about the device and the software version.

Garmin Devices: Provides information about connected Garmin devices.

Factory Settings: Restores the device to factory settings.

NOTE: This deletes any setting information you have entered.

My Vessel Settings

NOTE: Some settings and options require additional hardware. Select **Settings > My Vessel**.

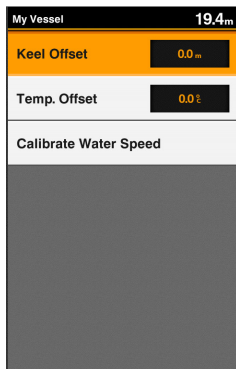

Keel Offset: Offsets the surface reading for the depth of a keel, making it possible to measure depth from the bottom of the keel instead of from the transducer location (page 40).

Temp. Offset: Compensates for the water temperature reading from a temperature-capable transducer (page 40).

Calibrate Water Speed: Calibrates the speed-sensing transducer or sensor page 41.

Transducer Type: Displays the type of transducer connected to the device (page 3).

Setting the Keel Offset

You can enter a keel offset to compensate the surface reading for the depth of a keel, making it possible to measure water depth or depth below the keel instead of depth below the transducer. Enter a positive number to offset for a keel. You can enter a negative number to compensate for a large vessel that may draw several feet of water.

NOTE: A buffer of 2 to 3 feet from the bottom of the keel is recommended to ensure a safe distance from the keel to the bottom.

1 Complete an action, based on the location of the transducer:

- If the transducer is installed at the water line ①, measure the distance from the transducer location to the keel of the boat. Enter this value in steps 3 and 4 as a positive number to display depth below keel.
- If the transducer is installed at the bottom of the keel ②, measure the distance from the transducer to the water line. Enter this value in steps 3 and 4 as a negative number to display water depth. Enter a 0 in this value to display depth below keel and depth below transducer.

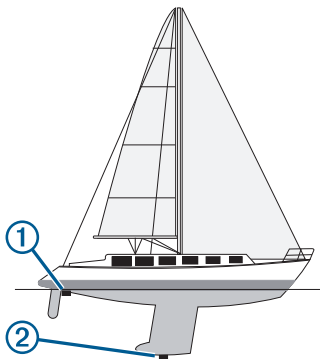

- 2 Select **Settings** > **My Vessel** > **Keel Offset**.
- 3 Select **+** or **-** based on the location of the transducer.
- 4 Enter the distance measured in step 1.

Setting the Water Temperature Offset

You can set the temperature offset to compensate for the temperature reading from a temperature-capable sensor.

- 1 Measure the water temperature using the temperature-capable transducer that is connected to the device.
- 2 Measure the water temperature using a different thermometer or temperature sensor that is known to be accurate.
- 3 Subtract the water temperature measured in step 1 from the water temperature measured in step 2.

This is the temperature offset. Enter this value in step 5 as a positive number if the sensor connected to the device measures the water temperature as being colder than it actually is. Enter this value in step 5 as a negative number if the sensor connected to the device measures the water temperature as being warmer than it actually is.

- 4 Select **Settings > My Vessel > Temp. Offset**.
- 5 Use the arrow keys to enter water temperature offset measured in step 3.

Calibrating a Water Speed Device

If you have a speed-sensing transducer connected to the chartplotter, you can calibrate that speed-sensing device to improve the accuracy of water-speed data displayed by the chartplotter.

- 1 Select **Settings > My Vessel > Calibrate Water Speed**.
- 2 Follow the on-screen instructions.
If the boat is not moving fast enough or the speed sensor is not registering a speed, a message appears.
- 3 Select **OK**, and safely increase the boat speed.
- 4 If the message appears again, stop the boat, and ensure the speed-sensor

wheel is not stuck.

- 5 If the wheel turns freely, check the cable connections.
- 6 If you continue to get the message, contact Garmin product support.

Alarms Settings

Navigation Alarms

Select **Settings > Alarms > Navigation**.

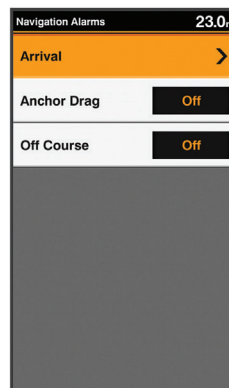

Arrival: Sets an alarm to sound when you are within a specified distance or time from a turn or a destination.

Anchor Drag: Sets an alarm to sound when you exceed a specified drift distance while anchored.

Off Course: Sets an alarm to sound when you are off course by a specified distance.

System Alarms

Select **Settings** > **Alarms** > **System**.

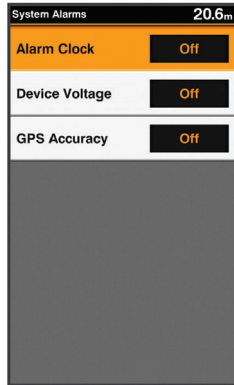

Alarm Clock: Sets an alarm clock.

Device Voltage: Sets an alarm to sound when the battery reaches a specified low voltage.

GPS Accuracy: Sets an alarm to sound when the GPS location accuracy falls outside the user-defined value.

Sonar Alarms

Select **Settings** > **Alarms** > **Sonar**.

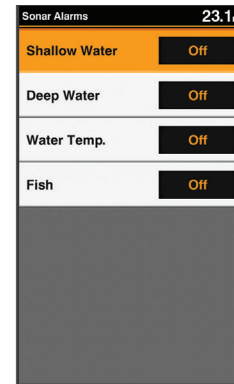



Shallow Water: Sounds when the water depth is shallower than the specified depth.

Deep Water: Sounds when the water depth is deeper than the specified depth.

Water Temp.: Sounds when the water temperature varies more than $\pm 2^{\circ}\text{F}$ ($\pm 1.1^{\circ}\text{C}$). Alarm settings are saved when the device is turned off.

NOTE: You must connect the device to a temperature-capable transducer to use this alarm.

Fish: Sets an alarm to sound when the device detects a suspended target.

-  sets the alarm to sound when fish of all sizes are detected.
-  sets the alarm to sound only when medium or large fish are detected.
-  sets the alarm to sound only when large fish are detected.

Unit Settings

Select **Settings > Units**.

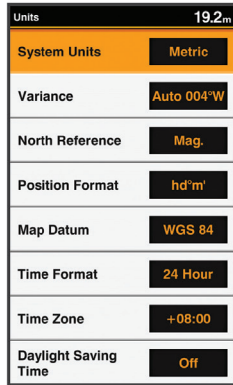

System Units: Sets the unit format for the device.

Variance: Sets the magnetic declination, the angle between magnetic north and true north, for your present location.

North Reference: Sets the direction references used in calculating heading information. True sets geographic north as the north reference. Grid sets grid north as the north reference (000°). Magnetic sets the magnetic north as the north reference.

Position Format: Sets the position format in which a given location reading appears. Do not change this setting unless you are using a map or chart that specifies a different position format.

Map Datum: Sets the coordinate system on which the map is structured. Do not change this setting unless you are using a map or chart that specifies a

different map datum.

Time Format: Sets a 12-hour, 24-hour, or UTC time format.

Time Zone: Sets the time zone.

Daylight Savings Time: Turns daylight savings time off or on.

Communications Settings

NOTE: Some settings and options require additional charts or hardware. Select **Settings > Communications**.

Serial Port: Sets the input/output format for the serial port to use when connecting the chartplotter to external NMEA devices, computers, or other Garmin devices.

NMEA 0183 Setup: Sets the NMEA 0183 sentences the chartplotter transmits, how many digits to the right of the decimal point are transmitted in a NMEA output, and how waypoints are identified (page 43).

NMEA 0183 Settings

Select **Settings > Communications > NMEA 0183 Setup**.

Sounder: Enables NMEA 0183 output sentences for the sounder (if applicable).

Route: Enables NMEA 0183 output sentences for routes.

System: Enables NMEA 0183 output sentences for system information.

Garmin: Enables NMEA 0183 output sentences for Garmin proprietary sentences.

Posn Precision: Adjusts the number of digits to the right of the decimal point for transmission of NMEA output.

XTE Precision: Adjusts the number of digits to the right of the decimal point for crosstalk error output.

Waypoint IDs: Sets the device to transmit waypoint names or numbers via NMEA 0183 while navigating. Using numbers may resolve compatibility issues with older NMEA 0183 autopilots.

MMSI: Allows you to enter your Mobile Marine Safety Identity (MMSI) number.

Diagnostics: Displays NMEA 0183 diagnostic information.

Defaults: Restores the NMEA 0183 settings to the original factory defaults.

Navigation Settings

NOTE: Some settings and options require additional charts or hardware.

Select **Settings > Navigation**.

Route Labels: Sets the type of labels shown with route turns on the map.

Auto Guidance: Sets the parameters the chartplotter uses when calculating an Auto Guidance path, when you are using some premium maps.

Turn Transition Activation: Sets the turn transition to be calculated based on time or distance.

Turn Transition Time: Sets how many minutes before the turn that you transition to it as the next leg, when Time is selected for the Turn Transition Activation setting. You can raise this value to help improve the accuracy of the autopilot when navigating a route or an Auto Guidance path with many frequent turns or at higher speeds. For straighter routes or slower speeds, lowering this value can improve autopilot accuracy.

Turn Transition Distance: Sets how far before the turn that you transition to it as the next leg, when Distance is selected for the Turn Transition Activation setting. You can raise this value to help improve the accuracy of the autopilot when navigating a route or an Auto Guidance path with many frequent turns or at higher speeds. For straighter routes or slower speeds, lowering this value can improve autopilot accuracy.

Route Start: Selects a starting point for route navigation.

Restoring the Factory Default Settings

NOTE: This deletes all settings information you have entered.

Select **Settings > System > System Information > Factory Settings**.

Appendix

Registering Your Device

Help us better support you by completing our online registration today.

- Go to support.garmin.com.
- Keep the original sales receipt, or a photocopy, in a safe place.

Sun Cover

The sun cover protects the screen when the device is not in use.

NOTE: The sun cover is an optional accessory that is sold separately. To remove the cover, hold the cover at the tab ①, and pull forward.

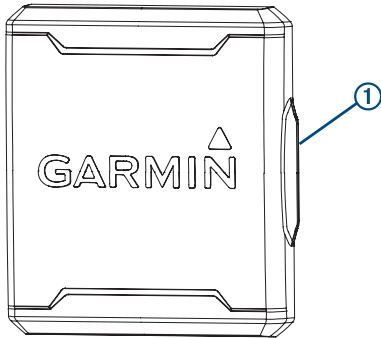

GPSMAP 585 Plus Specifications

Item	Measurement
Dimensions (W x H x D)	176 x 190 x 81.8 mm (6.94 x 7.5 x 3.25 in)
Weight	816 g (1.8 lbs)
Screen size	6 inch
Display size (W x H)	72 x 136.2 mm (2.83 x 5.36 in)
Display resolution (W x H)	480 x 800 pixels
Display type	WVGA display
Water rating*	IEC 60529 IPX7
GPS receiver	GPS/GLONASS/BeiDou, internal
NMEA 0183/RS422 compatible	√
Temperature range	From -15° to 55°C (from 5° to 131°F)
Input power	From 10 to 36 Vdc
Typical current draw	0.8 A
Power consumption	7.6 W
Max. power usage	23 W @ 12 Vdc
Mounting options	Bail or flush

Item	Measurement
Preloaded maps	GPSMAP 585 Plus, APAC (worldwide basemap) GPSMAP 585 Plus, w/g2, SEA (built-in SEA g2 chart)
Accepts data cards	2 standard SD
Waypoints	12,000
Routes	200
Track log	one 50,000 points active track; 100 saved tracks

Item	Measurement
Garmin Sonar compatible	√
Supports AIS (tracks target ships position)	√
Supports DSC (displays position data from DSC-capable VHF radio)	√
Tide tables	√
Transmit power**	600W (RMS)
Sonar Frequency	Traditional: 50/77/200 kHz CHIRP: Low (40-60 kHz), Mid (80-165 kHz), High (150-240 kHz)
ClearVü™	Built-in scanning sonar module
Scanning Sonar Frequency	CHIRP 260/455/800kHz
Maximum depth***	701 m (2300 ft.) freshwater, 335 m (1100 ft.) seawater at 77 kHz
Bottom lock (shows return from the bottom up)	√
Water temperature log and graph	√
Split-screen zoom	√
Fish Symbol ID (helps identify fish targets)	√
Sonar recording	√
Sonar history rewind	√
Compass-safe distance	30 cm (11.8 in.)
Fuse	6 A
Max. waypoints	12,000
8-Pin Power/NMEA 0183 Connector	1
BNC for External GPS Antenna	1

* The device withstands incidental exposure to water of up to 1 m for up to 30 min. For more information, go to www.garmin.com/waterrating.

** Dependent upon transducer rating and depth.

*** Dependent upon the transducer, water salinity, bottom type, and other water conditions.

Troubleshooting

My device does not turn on

- Push the power cable all the way into the back of the device. Even if the cable seems to be connected, you should push firmly so that it is fully seated.
- Make sure the power source is generating power. You can check this several ways. For example, you can check whether other devices powered by the source are functioning.
- Check the fuse in the power cable. The fuse should be located in a holder that is part of the red wire of the power cable. Check that the proper size fuse is installed. Refer to the label on the cable or the installation instructions for the exact fuse size needed. Check the fuse to make sure there is still a connection inside of the fuse. You can test the fuse using a multimeter. If the fuse is good, the multimeter reads 0 ohm.
- Check to make sure the device is receiving at least 10 Vdc, but 12 Vdc is recommended. To check the voltage, measure the female power and ground sockets of the power cable for DC voltage. If the voltage is less than 10 Vdc, the device will not turn on.

My sonar does not work

- Push the transducer cable all the way into the back of the device. Even if the cable seems to be connected, you should push firmly so that it is fully seated.
- Check to make sure the sonar transmission is turned on.

My device is not creating waypoints in the correct location

You can manually enter a waypoint location to transfer and share data from one device to the next. If you have manually entered a waypoint using coordinates, and the location of the point does not appear where the point should be, the map datum and position format of the device may not match the map datum and position format originally used to mark the waypoint.

Position format is the way in which the GPS receiver's position appears on the screen. This is commonly displayed as latitude/longitude in degrees and minutes, with options for degrees, minutes and second, degrees only, or one of several grid formats.

Map datum is a math model which depicts a part of the surface of the earth. Latitude and longitude lines on a paper map are referenced to a specific map datum.

- 1 Find out which map datum and position format was used when the original waypoint was created.

If the original waypoint was taken from a map, there should be a legend on the map that lists the map datum and position format used to create that map. Most often this is found near the map key.

- 2 Select **Settings > Units**.
- 3 Select the correct map datum and position format settings.
- 4 Create the waypoint again.

物質宣言

部件名称	有毒有害物质或元素					
	铅	汞	镉	六价铬	多溴联苯	多溴二苯醚
印刷电路板组件	X	O	O	O	O	O
屏幕 / 背光	X	X	O	O	O	O
金属零件	X	O	O	O	O	O
电缆 电缆组件 连接器	X	O	O	O	O	O

本表格依据 SJ/T11364 的规定编制。

O: 代表此种部件的所有均质材料中所含的该种有害物质均低于 (GB/T26572) 规定的限量。

X: 代表此种部件所用的均质材料中, 至少有一类材料其所含的有害物质高于 (GB/T26572) 规定的限量。

* 該產品說明書應提供在環保使用期限和特殊標記的部分詳細講解產品的擔保使用條件。



e-mail marketing.asia@garmin.com, or call Garmin Asia at +886-2-26421999 ext2.



© 2017 Garmin Ltd. or its subsidiaries

Garmin International, Inc.

1200 East 151st Street, Olathe, Kansas 66062, USA

Garmin (Europe) Ltd.

Liberty House, Hounsdown Business Park, Southampton, Hampshire, SO40 9LR, UK

Garmin Corporation

No.68, Zhangshu 2nd Road, Xizhi Dist., New Taipei City, 221, Taiwan



June 2017

190-02144-02 Rev. A



Printed in Taiwan